



Installation instructions

Akrapovič Exhaust System:

Downpipe

for the

Mercedes AMG A45 / A45 S (W177)

Mercedes AMG CLA45 / CLA45 S (C118/X118)

ENGLISH

Version 1.2

01/2022



www.akrapovic.com

D249.1.00.0000 B



Installation instructions

Akrapovič Exhaust System:

Downpipe

for the

Mercedes AMG A45 / A45 S (W177)

Mercedes AMG CLA45 / CLA45 S (C118/X118)

ENGLISH

Version 1.2

01/2022

www.akrapovic.com

D249.1.00.0000 A

Congratulations on purchasing the Akrapovič product. The Akrapovič product is made by Akrapovič d.d., Malo Hudo 8a, 1295 Ivančna Gorica, Slovenia ("Akrapovič").

Please read this entire installation manual carefully prior to installing and using the Akrapovič product.

Akrapovič product should only be installed by persons skilled in car exhaust system or other car parts installation and performance. The instructions provided in this manual should be followed to ensure proper installation and safe use of the Akrapovič product. Akrapovič and/or its partners shall not be held liable for any damage or personal injury (including direct, indirect, or consequential damage) sustained as a result of improper installation of the Akrapovič product or its use and maintenance contrary to the instructions and warnings contained herein.

If you have any questions regarding the installation and/or proper use of the Akrapovič product or this manual, please contact your local Akrapovič partner.

For more information on the Akrapovič products, see the official Akrapovič website at: <http://www.akrapovic.com>

GENERAL INFORMATION

Your safety is our number one priority. Please drive your car responsibly, safely and always obey local traffic rules.

All statements made with regard to the product's compliance are made in respect of the product "as is". Any modifications of the Akrapovič product or its improper installation, use or maintenance that is not in accordance with this Installation manual, may result in severe damage to the product, vehicle and/ or engine, as well as personal injury, and may affect the product's compliance with the legal requirements, such as product's air and/ or noise emissions (as an example, the car may not be suitable for use on public roads any longer), as well as warranty coverage.

The product may only be used in accordance with relevant laws and regulations, including state and federal, where applicable.

Damage caused by improper installation, use and maintenance of the Akrapovič product is not covered by the Akrapovič warranty. Please refer to the enclosed warranty with regard to the terms of our warranty.

Technical specifications of Akrapovič products are subject to change without notice.

COPYRIGHT AND OTHER RIGHTS NOTICE

The Akrapovič trademark, including corporate logos and emblems, are subject to copyright as well as trademark rights of Akrapovič, its licensors, or third persons authorizing Akrapovič to use them.

Any reproduction, technical or other manipulation, translation, or other use of the copyright and/or trademark rights contained herein is prohibited without the explicit prior written consent of Akrapovič. The same especially applies to the entire contents of this manual and/or any of its parts, including but not limited to technical specifications, instructions, graphs, photographs, and so on included in this manual.

Akrapovič takes all copyright and other rights infringement cases under serious consideration. If you have any reason to believe that your product is not an original Akrapovič product, please contact our local partners or Akrapovič at info@akrapovic.com.

SAFETY AND COMPLIANCE WARNING, PLEASE READ CAREFULLY

BEFORE REMOVING THE STOCK PARTS AND BEGINNING THE INSTALLATION OF YOUR NEW AKRAPOVIČ PRODUCT, PLEASE MAKE SURE THAT ALL ITEMS LISTED BELOW ARE VERIFIED:

- This manual is specific to the car indicated on the cover page, for which it is designed. Installation procedures vary depending on the type of car. Please verify that the Akrapovič **product and this installation manual correspond to the type of your car.**
- **For exhaust system only:** the exhaust system can get extremely hot during and after it is used. Make sure not to touch the exhaust system until it is completely cool. **Allow the exhaust and engine to cool down before beginning installation.**
- Make sure the car is **securely positioned to prevent** damage to yourself and other, or the car.
- Please check the parts you received against the parts list available on our website (please use the QR code on the front page or look for “schematic view” in the respective product page on www.akrapovic.com). Make sure that you have **all the parts necessary for the installation** of your new Akrapovič product. If any of the parts is missing, please do not proceed with uninstalling your stock parts/installing the Akrapovič product and contact the retailer where you purchased the Akrapovič product.
- **For exhaust system only:** every exhaust system muffler has its unique serial number, which identifies the authenticity of the product. You can find the serial number on the muffler's sleeve. Please refer to the **picture 1**. Please verify that your exhaust system is an original Akrapovič product. If you have any doubts, please contact the reseller where you purchased the exhaust system or Akrapovič partners. This manual, any certificates and Akrapovič warranty apply to original products only.

GENERAL NOTE

Photographs and other illustrations in this manual are symbolic and are intended to help represent individual steps for proper installation and use, as well as for a general overview. The actual component parts of the Akrapovič product may not entirely correspond to the photographs and other illustrations.

Picture 1 - EXAMPLE OF SERIAL NUMBER POSITION:

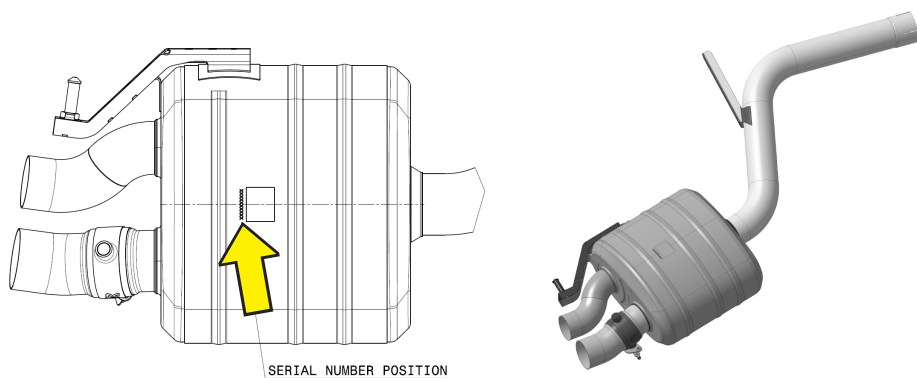

NOISE AND EMISSION WARNINGS

General warning

Because of the world-wide distribution of Akrapovič d.d. products, neither Akrapovič d.d. nor any of its subsidiaries make any representation that the products comply with the air and/or noise emissions laws, or labeling laws, of any jurisdiction. The purchasers are entirely responsible for informing themselves of the applicable laws where the products are to be used and to comply with those law.

Although legal compliance of Akrapovič products in a specific country should be determined by the user, you can find some basic guidance on compliance of your Akrapovič product with various legal requirements on the product-related part of our website (please use the QR code on the front page or look for the respective product page on www.akrapovic.com). For EC and ECE type approvals, please refer to the certificate enclosed to your product.

USA WARNING

Various U.S. states and the U.S. federal government have individual laws regulating the use of aftermarket parts and systems, especially as those parts and systems modify, remove, or replace original equipment catalysts. Please consult the appropriate laws in your area before installing any aftermarket part or system on your vehicle to ensure compliance with all applicable laws. Neither Akrapovic d.d. nor any of their subsidiaries or the sellers of the parts or systems make any representation that any of their parts or systems comply with any such laws.

CALIFORNIA WARNING

California laws prohibit the use of any aftermarket part or system that modifies, removes or replaces original equipment catalysts unless the California Air Resources Board has issued an Executive Order regarding such part or system or unless the part or system is exempted by being used only on racing vehicles on closed courses. Neither Akrapovic d.d. nor any of their subsidiaries make any representation that any of their parts or systems has received such an Executive Order or that any of their parts or systems conform with the racing vehicles exemption. The purchasers are entirely responsible for informing themselves of applicable California laws and to comply with those laws.

SYMBOLS

The following symbols are used throughout these installation instructions:



TOOLS AND PROTECTIVE EQUIPMENT REQUIRED



TIGHTENING TORQUE



LUBRICATION



HAND TIGHTEN



INSTALLATION TIP



CAUTION OR IMPORTANT

USE BOLT SEALANT

Apply 3 to 4 small drops of bolt sealant onto the cleaned and degreased threads before tightening the bolts.

WARNING! Avoid contact with skin, eyes and mucous membranes. Do not inhale fumes. Keep out of reach of children.



USE ANTI-SEIZE LEAD-FREE COPPER PASTE (black tube)

Provides trouble-free and long-lasting protection against seizing, corrosion and rusting of bolts, threaded ends, nuts, joints, etc. Also protects against vibration, wear and impact. **WARNING! Avoid eye contact. Keep out of reach of children.**



USE ANTI-SEIZING GREASE (white tube)

Prevents seizing, corrosion and excessive wear between the titanium components. **WARNING! Avoid eye contact. Keep out of reach of children.**



Tools & equipment



- Mechanic gloves
- T-handle 8 mm wrench
- T-handle 13 mm wrench
- Torx swivelling E9
- Torx swivelling E10
- Torx swivelling E12
- Torx swivelling E14
- Torx swivelling E18
- Socket 11 mm
- Combination 13 mm wrench
- Combination 15 mm wrench
- Combination 16 mm wrench
- Flat screwdriver
- Pry bar
- Socked for lambda probes 22 mm

PARTS LIST

The packaging box should contain one or more of the following items:

- Akrapovič product
- Homologation certificate/ compliance documents if applicable
- Warranty
- Fitting material
- Installation Manual

Detailed list of parts can be found on the Akrapovič website (please use the QR code on the front page or look for “Schematic view” in the respective product page on www.akrapovic.com).

IMPORTANT: The car should be in the off position throughout the dismantling and installation process, as well as any other work done on the Akrapovič product!

REMOVAL OF STOCK EXHAUST SYSTEM OR OTHER VEHICLE'S STOCK PARTS:

The process of uninstalling the original exhaust system or other parts may vary depending on the existing exhaust system or other vehicle parts. Please follow the original vehicle manufacturer's workshop manual for uninstalling the original exhaust system or other parts.

If you for any reason decide otherwise, please note that any information provided in this respect herein should be considered as general information provided for your convenience only. Akrapovič shall not assume any liability or responsibility with regard to uninstalling your existing exhaust system or other parts, warranty coverage of such exhaust system or other parts vehicle or their further fitness for use.

In case your Akrapovič exhaust system or other vehicle parts may not be used on certain roads or under certain conditions, please keep the stock (or other) exhaust system or other parts that you can use in such circumstances legally.

REMOVAL OF STOCK EXHAUST SYSTEM:

Put the vehicle onto a car lift.

! **CAUTION:** ensure that the car is lifted safely and properly in order to avoid the risk of vehicle damage, injury, or even death!

1. Remove the exhaust system off the vehicle; check the **Evolution** exhaust system installation manual for details.
2. Unscrew the marked bolts and remove the under-engine panel off the vehicle (**F 01**).

! **CAUTION:** make sure not to injure yourself or damage any part of the vehicle during this process!

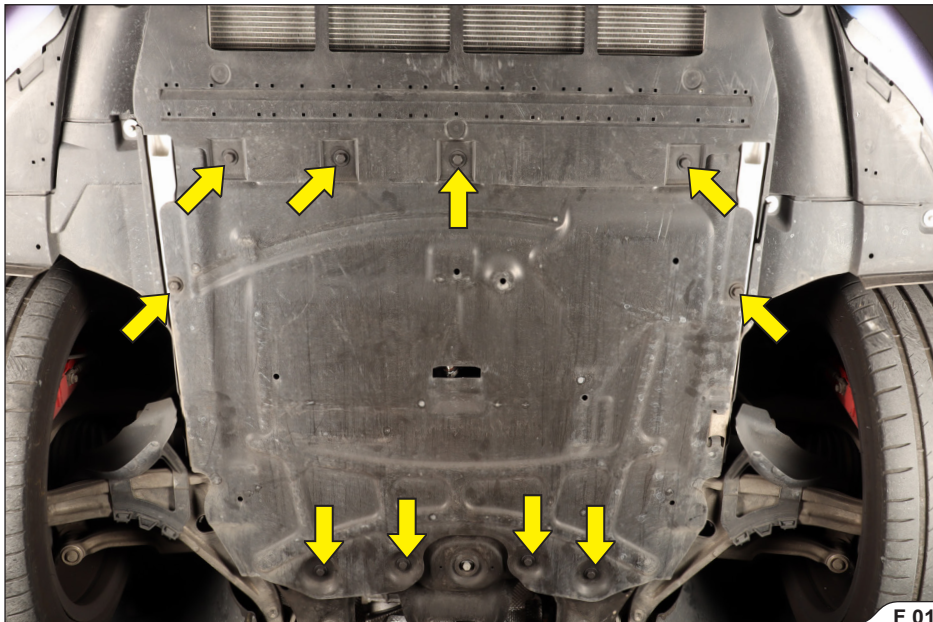

F 01

3. Unscrew marked bolts and remove the engine bracket off the vehicle (F 02).

! **CAUTION:** make sure not to injure yourself or damage any part of the vehicle during this process!

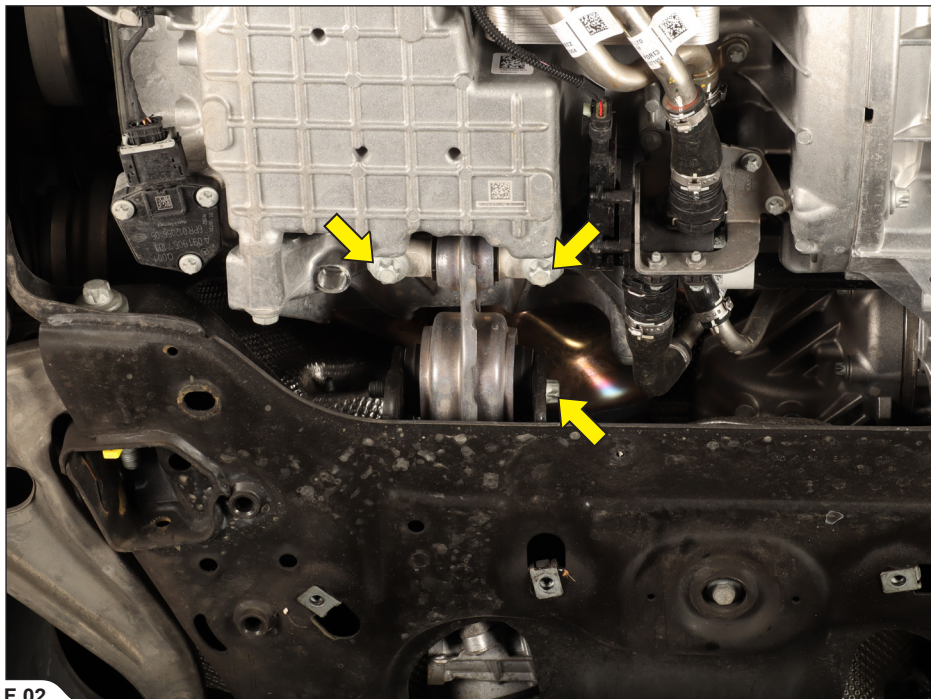

F 02

4. Unscrew marked clamp and remove the flexible pipe off the vehicle (F 03).

! **CAUTION:** make sure not to injure yourself or damage any part of the vehicle during this process!

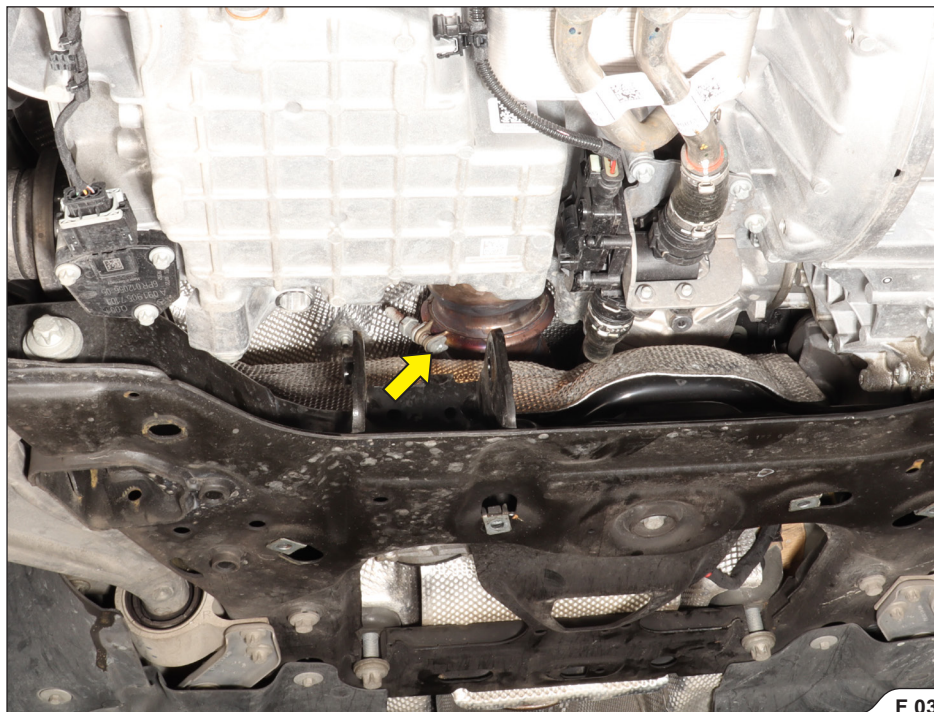

F 03

5. Loosen marked down pipe's bracket nut and unscrew marked bolts (F 04).

! **CAUTION:** make sure not to injure yourself or damage any part of the vehicle during this process!

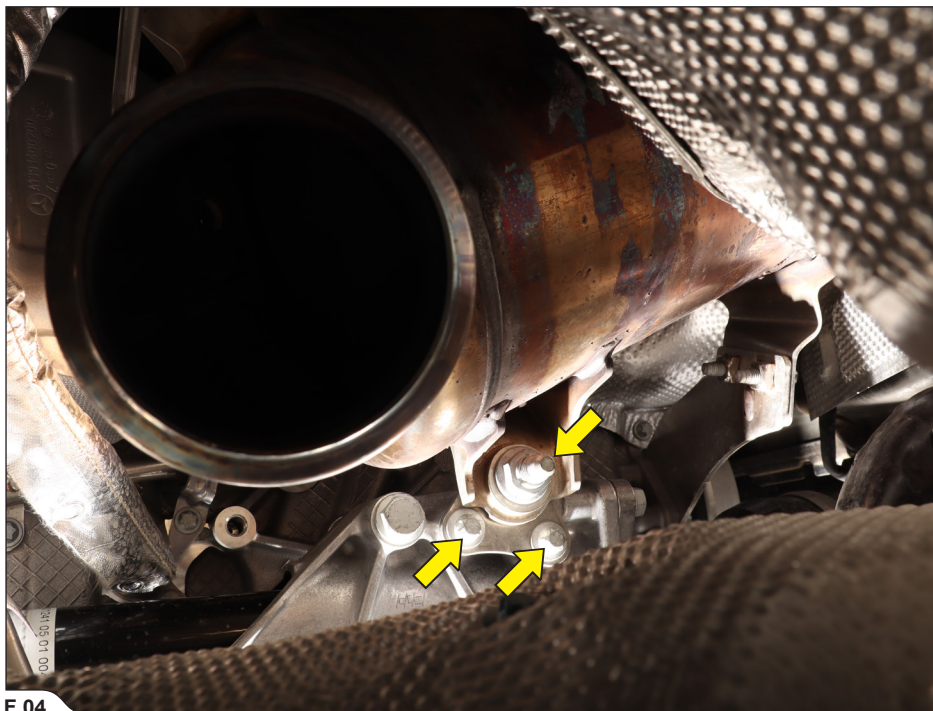

F 04

6. **For vehicles with OPF/GPF only:** unscrew marked OPF/GPF sensor and if your vehicle has one, unscrew the marked EGT sensor (**F 05**).

!

CAUTION: make sure not to injure yourself or damage any part of the vehicle during this process!

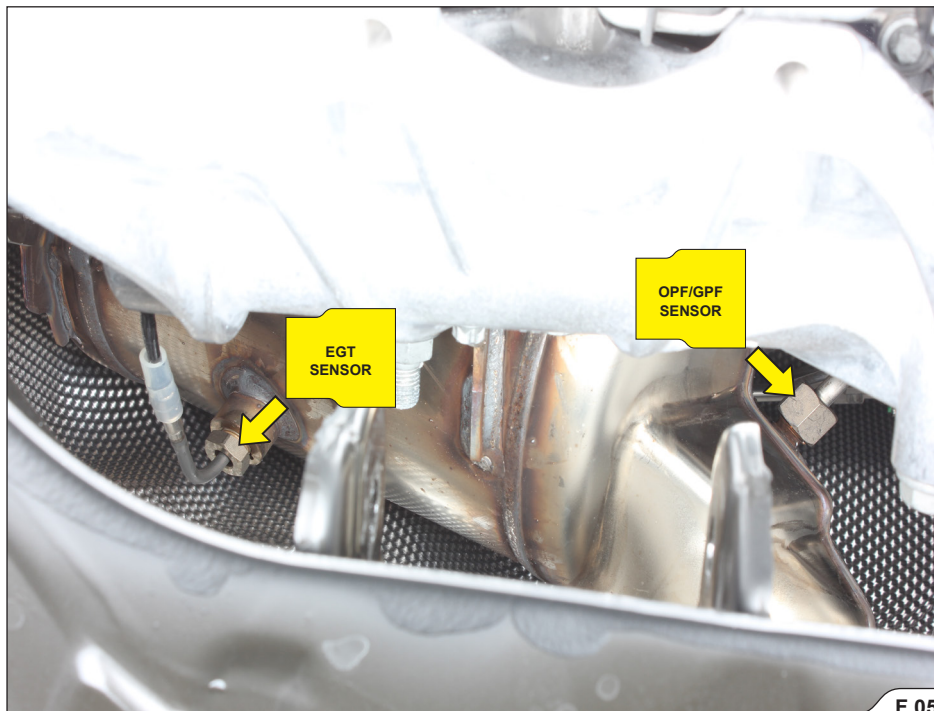

F 05

7. Unscrew marked bolts and remove the chassis reinforcement and engine cover off the vehicle; check your vehicle workshop manual for details (F 06).

! **CAUTION:** make sure not to injure yourself or damage any part of the vehicle during this process!



F 06

8. Unscrew all marked bolts, remove the heat shield and unscrew the lambda sensor and if your vehicle has one, unscrew the marked EGT sensor (F 07).

! **CAUTION:** make sure not to injure yourself or damage any part of the vehicle during this process!

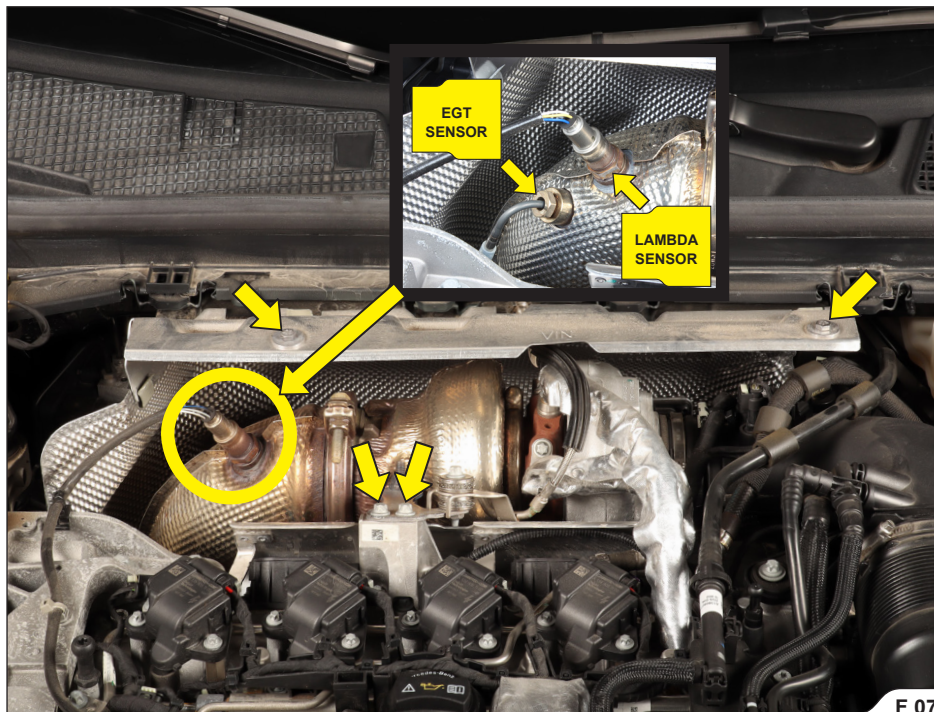

9. Unscrew marked nut, undo marked clamp and remove the turbocharger's cooling tube off the vehicle (F 08, 09).

! **CAUTION:** make sure not to injure yourself or damage any part of the vehicle during this process!

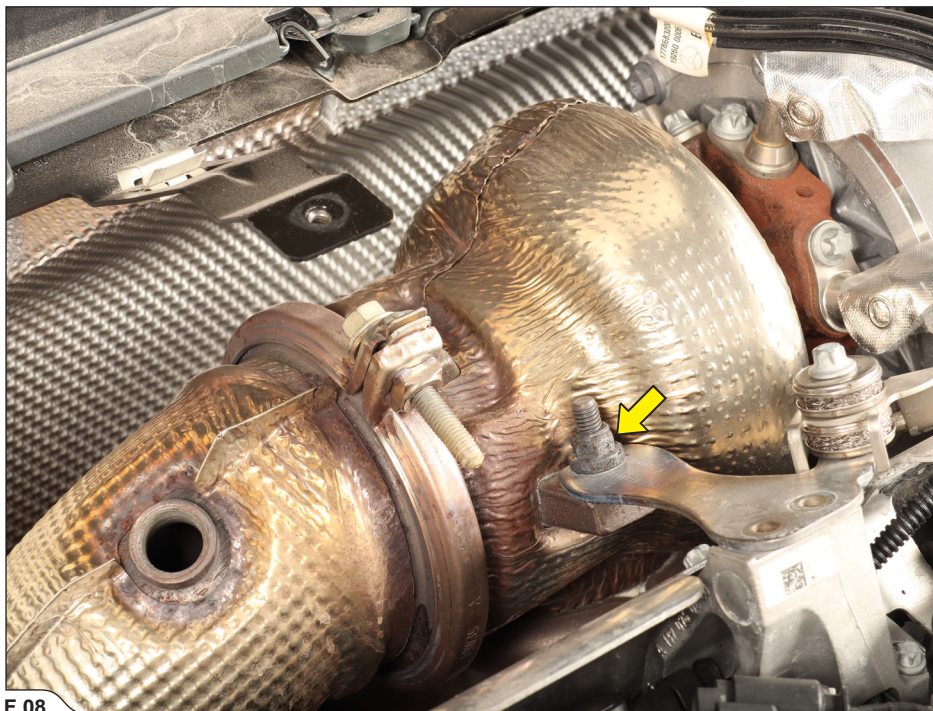

F 08

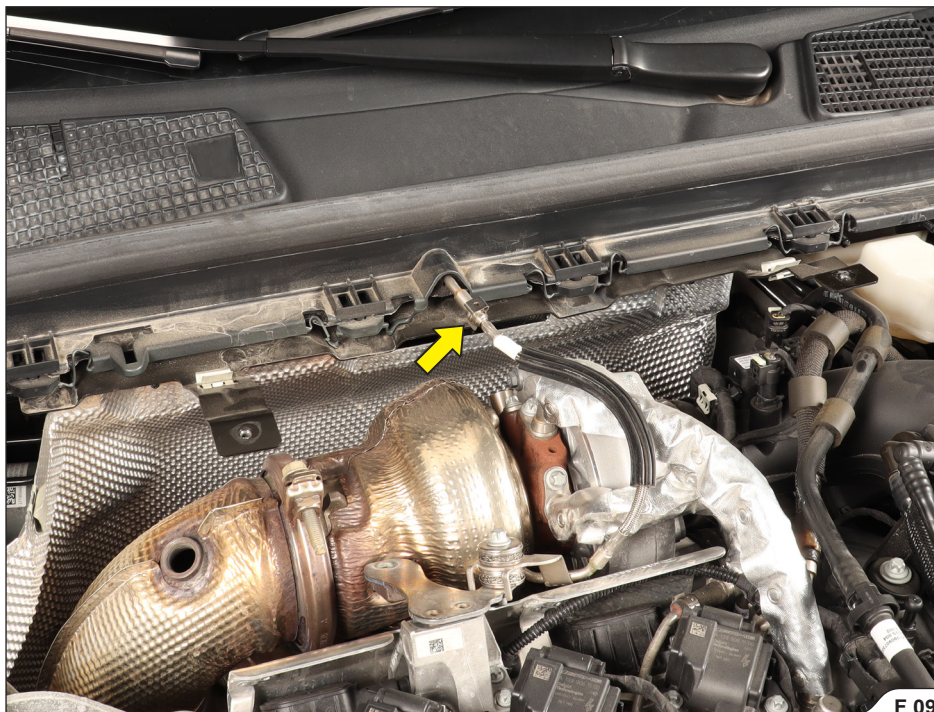

F 09

10. Unscrew marked fire wall nuts and partially remove the fire wall as shown (F 10, 11).

! **CAUTION:** make sure not to injure yourself or damage any part of the vehicle during this process!

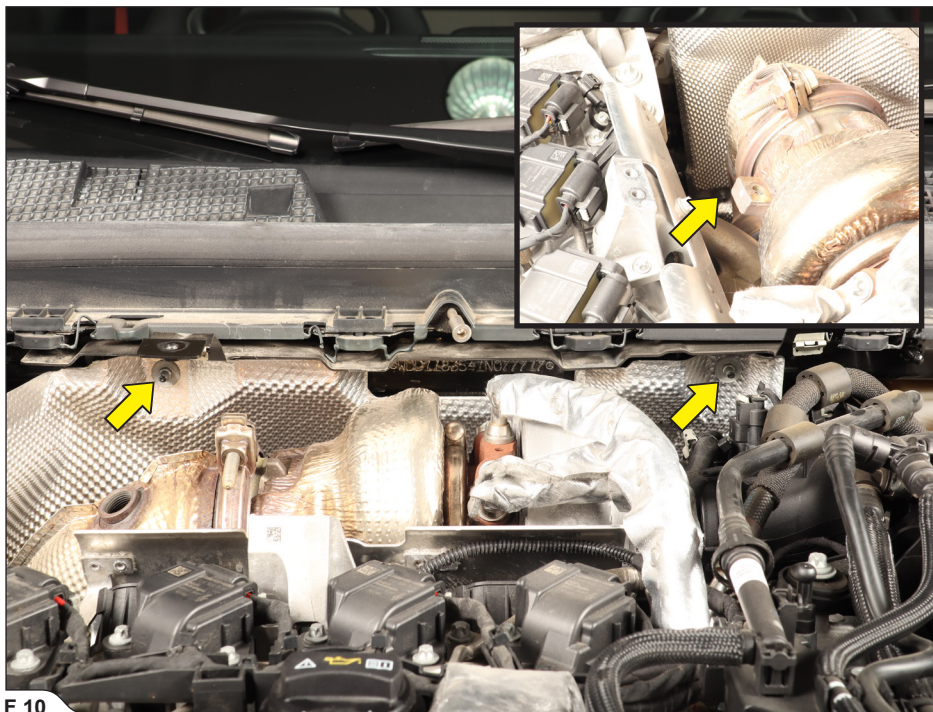

F 10

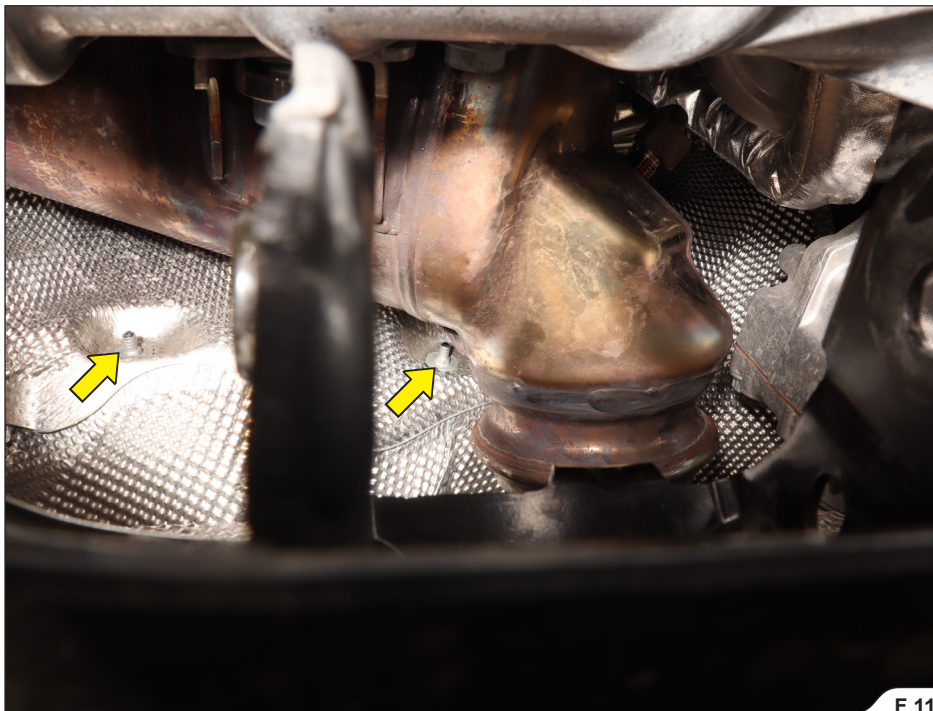

11. Unscrew marked nuts and remove the heat shield's bracket off the vehicle (F 12).

! **CAUTION:** make sure not to injure yourself or damage any part of the vehicle during this process!

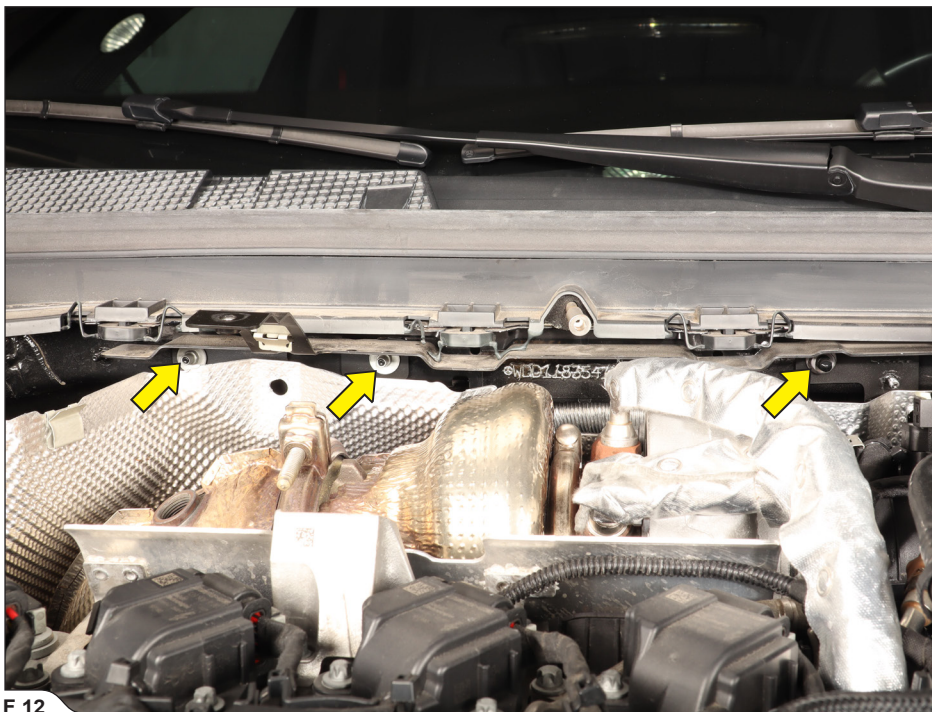

F 12

12. Carefully pull the fire wall out of the engine compartment (F 13).

! **CAUTION:** make sure not to injure yourself or damage any part of the vehicle during this process!

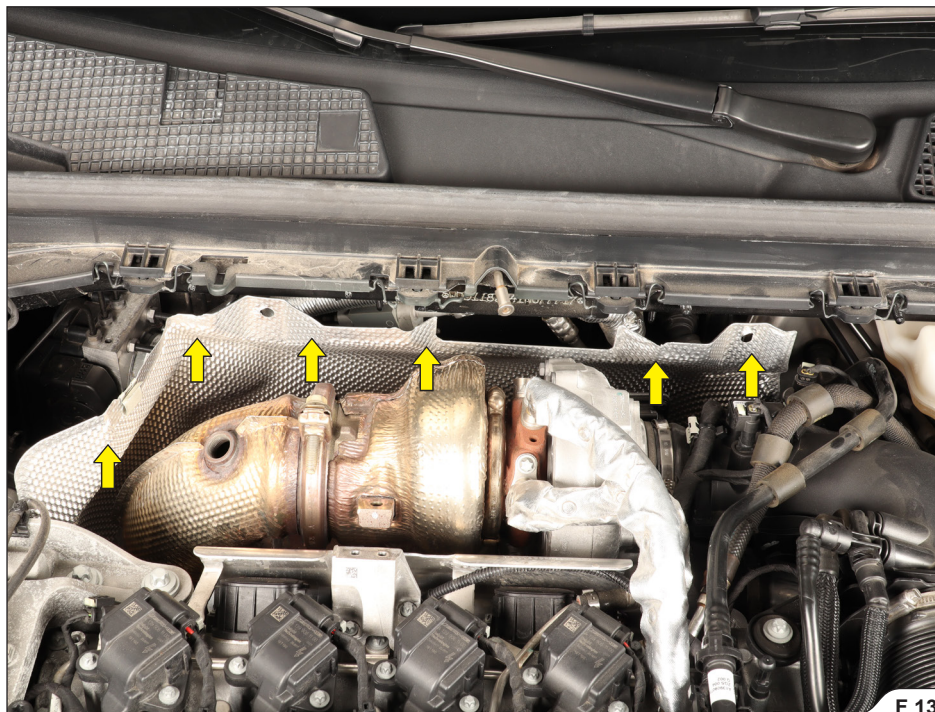

F 13

13. Unscrew the marked lambda and OPF/GPF sensors (for OPF/GPF vehicles only) and if your vehicle has one, unscrew the marked lower EGT sensor (F 14).

! **CAUTION:** make sure not to injure yourself or damage any part of the vehicle during this process!

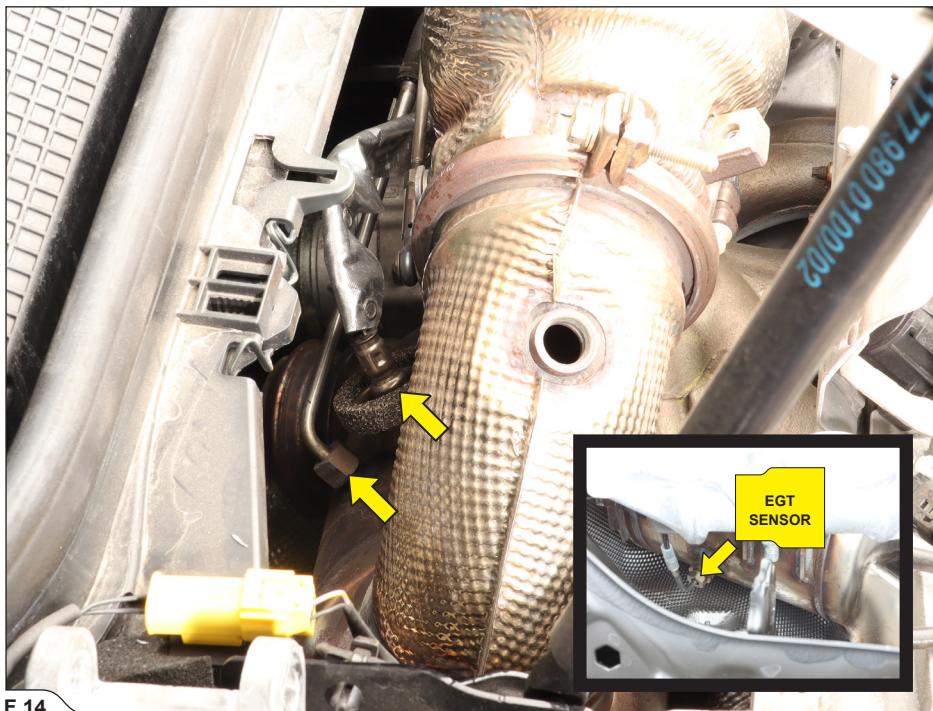

F 14

14. Unscrew marked down pipe's bracket bolts (F 15).

! **CAUTION:** make sure not to injure yourself or damage any part of the vehicle during this process!

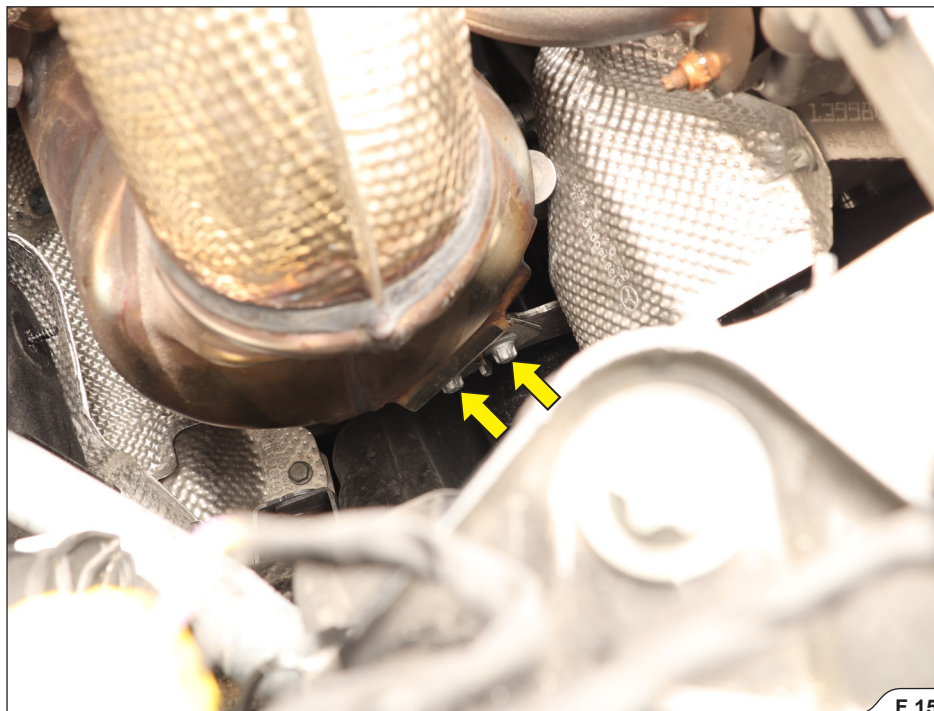

F 15

15. Unscrew marked clamp, move it off the joint and partially remove the down pipe (F 16).

! **CAUTION:** make sure not to injure yourself or damage any part of the vehicle during this process!

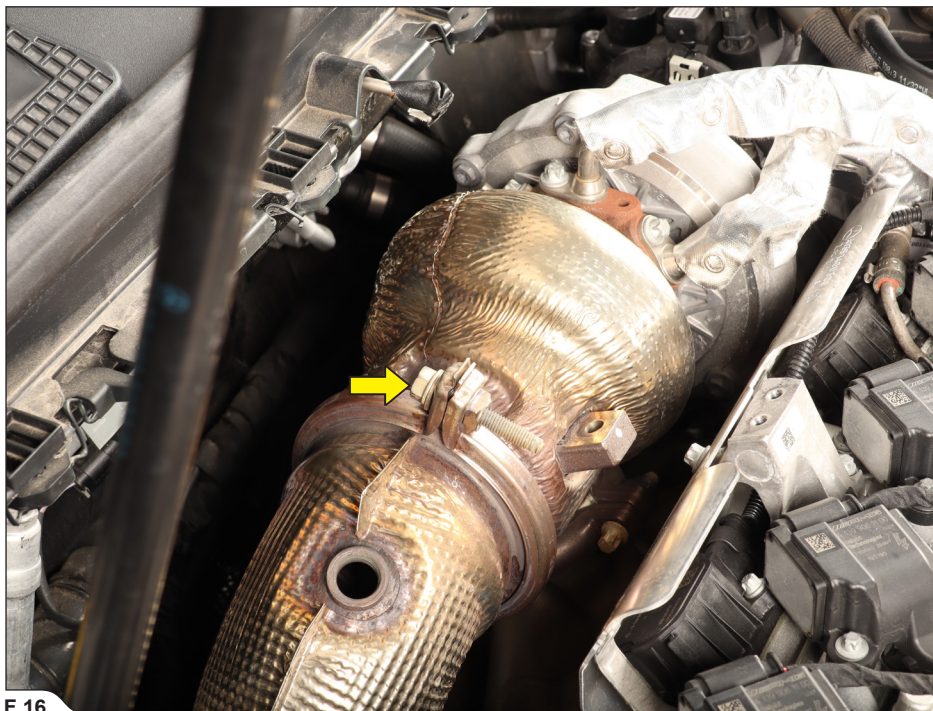

F 16

16. For vehicles with OPF/GPF only: unscrew marked OPF/GPF sensor bracket (F 17).

! **CAUTION:** make sure not to injure yourself or damage any part of the vehicle during this process!

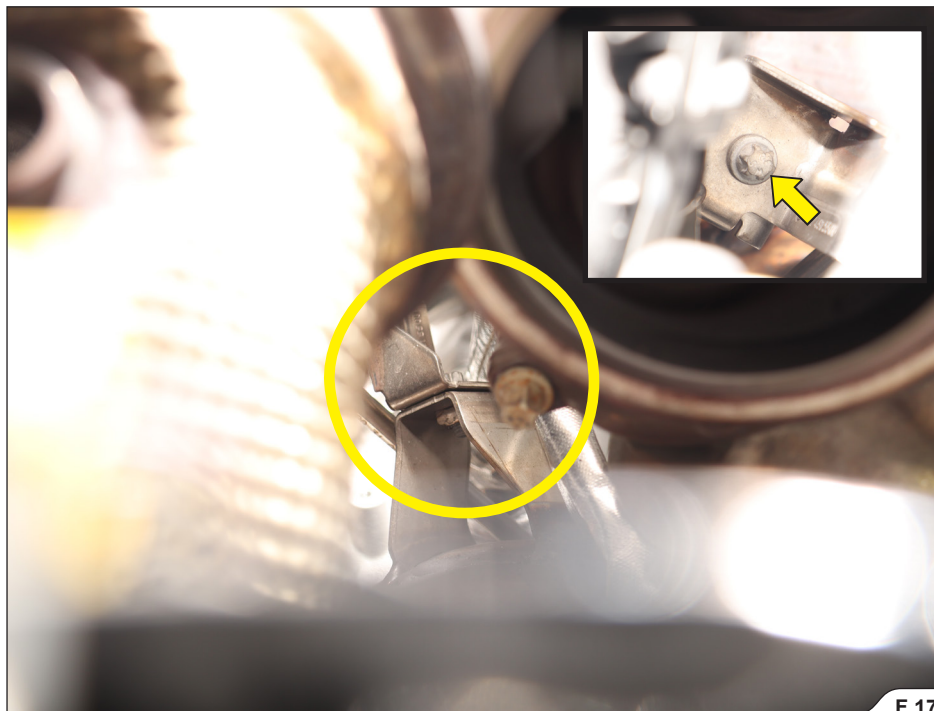

F 17

17. Unscrew and partially remove marked turbochargers oil line (F 18).

! **CAUTION:** make sure not to injure yourself or damage any part of the vehicle during this process!

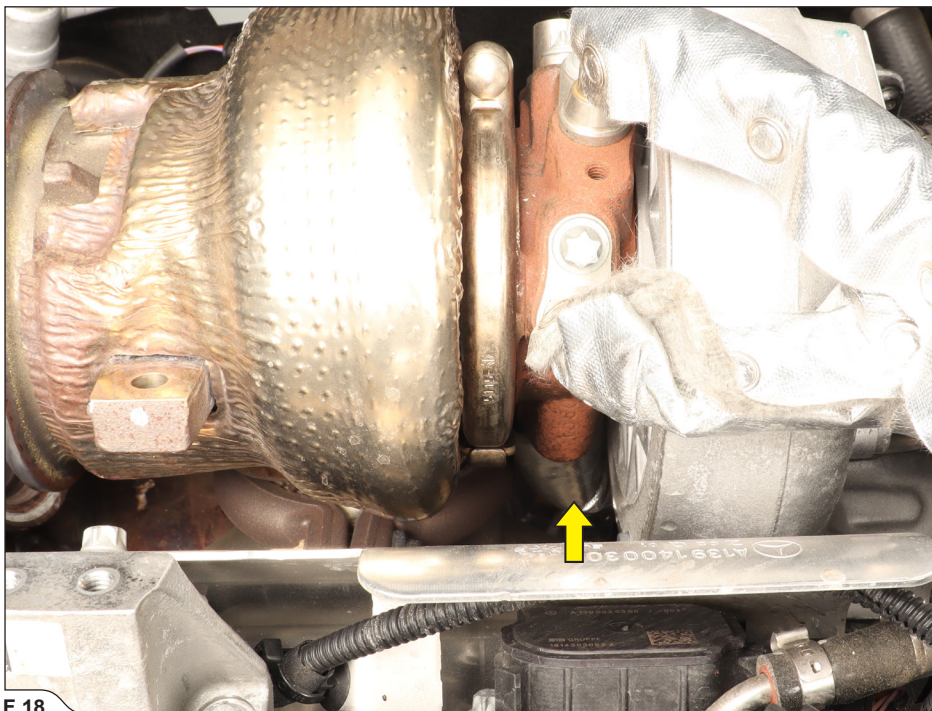

F 18

18. Remove the locking washers and unscrew all header nuts (F 19, 20).

! **CAUTION:** make sure not to injure yourself or damage any part of the vehicle during this process!

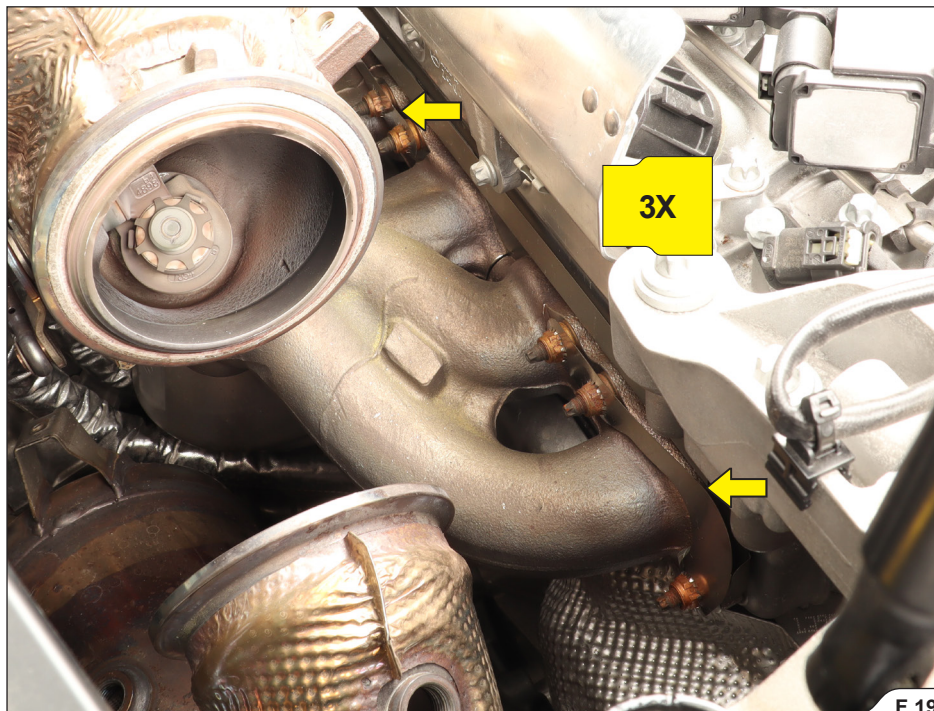

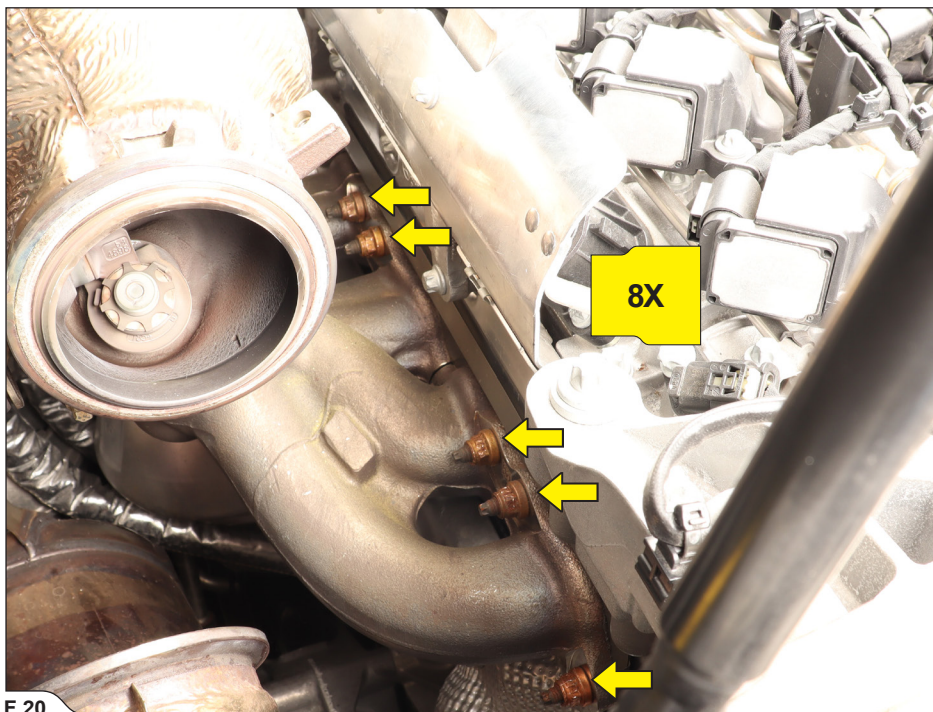

F 20

19. Unscrew marked header clamp bolts, undo the clamp and carefully remove the header off the vehicle (F 21).

! **CAUTION:** make sure not to injure yourself or damage any part of the vehicle during this process!

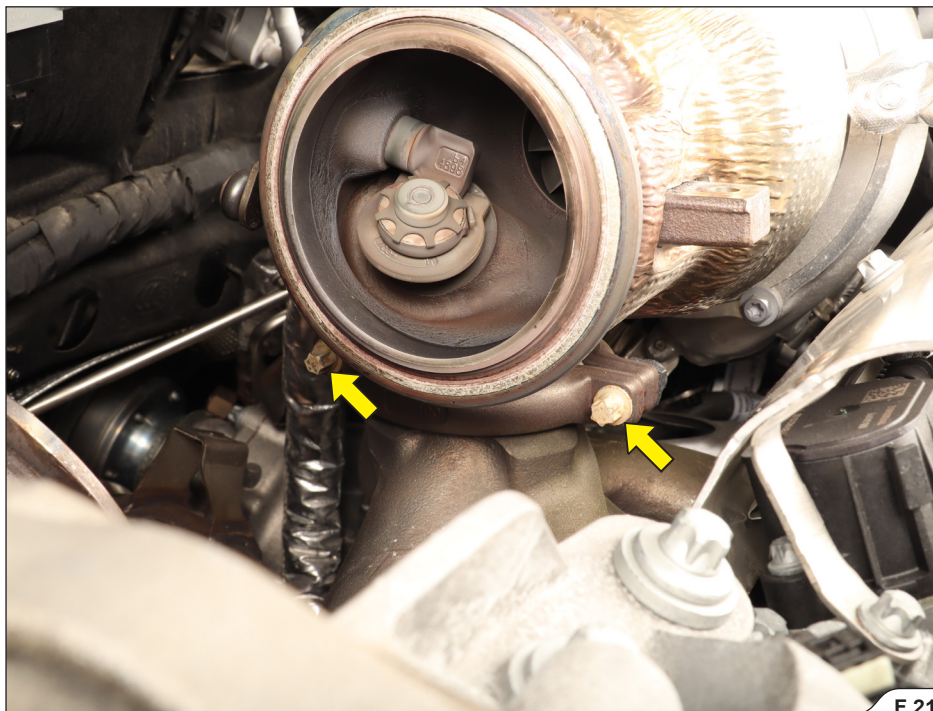

F 21

20. Carefully remove the down pipe off the vehicle (F 22).

! **CAUTION:** make sure not to injure yourself or damage any part of the vehicle during this process!



F 22

21. Unscrew marked nut and remove the down pipe's bracket (F 23).

! CAUTION: make sure not to injure yourself or damage any part of the vehicle during this process!



F 23

22. Untighten marked clamps and remove the air-intake tube (F 24).

! **CAUTION:** make sure not to injure yourself or damage any part of the vehicle during this process!

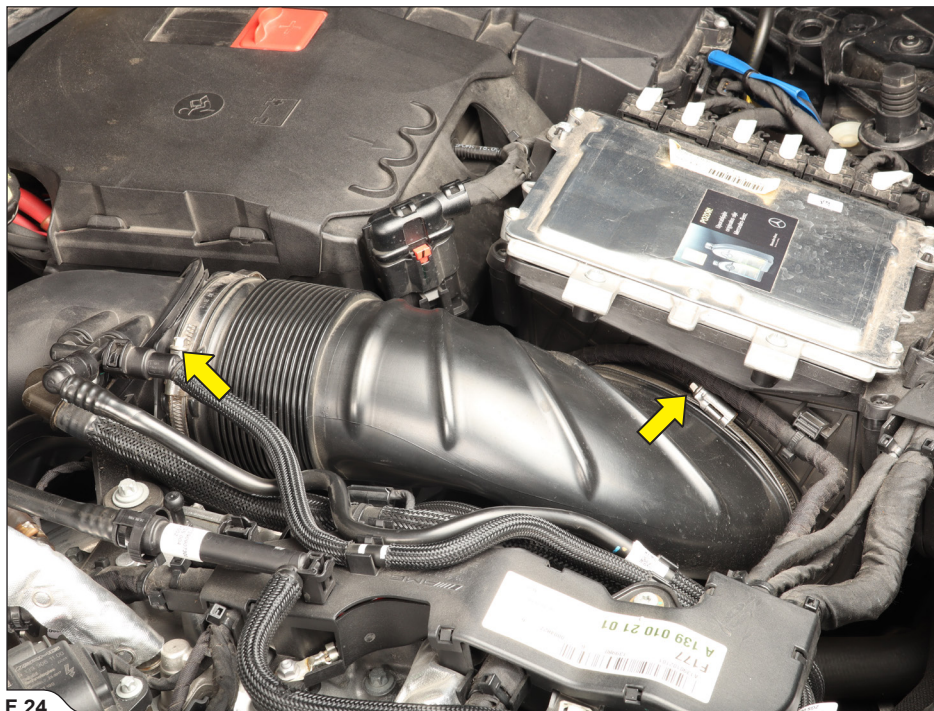

F 24

23. **For vehicles with OPF/GPF only:** undo marked OPF/GPF sensor electric lead, unscrew marked OPF/GPF sensor bracket bolts and remove the OPF/GPF sensor off the vehicle (F 25, 26).

! CAUTION: make sure not to injure yourself or damage any part of the vehicle during this process!

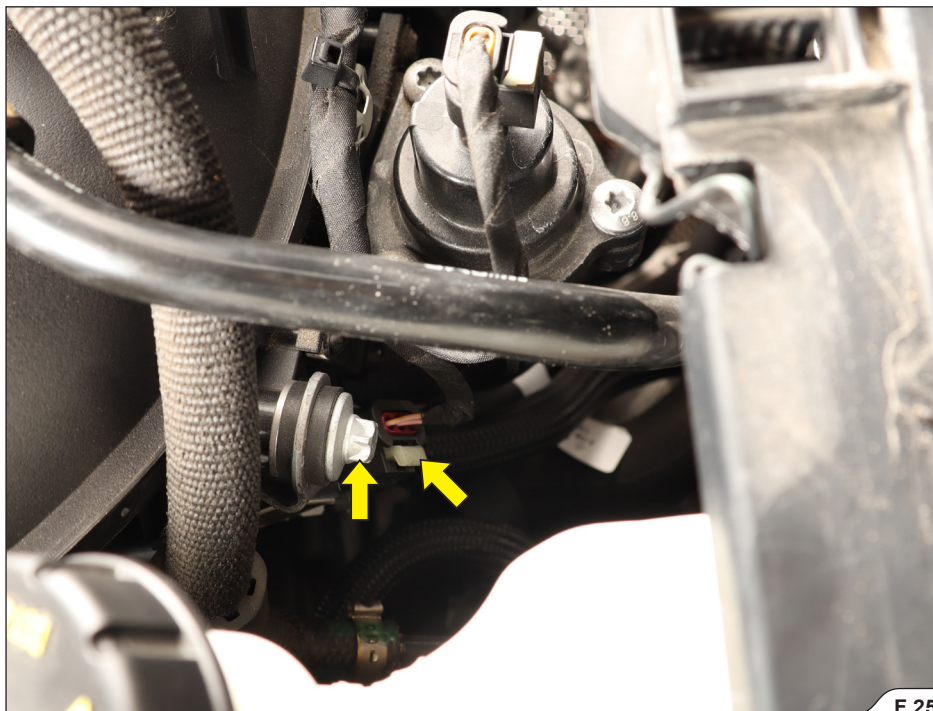

F 25

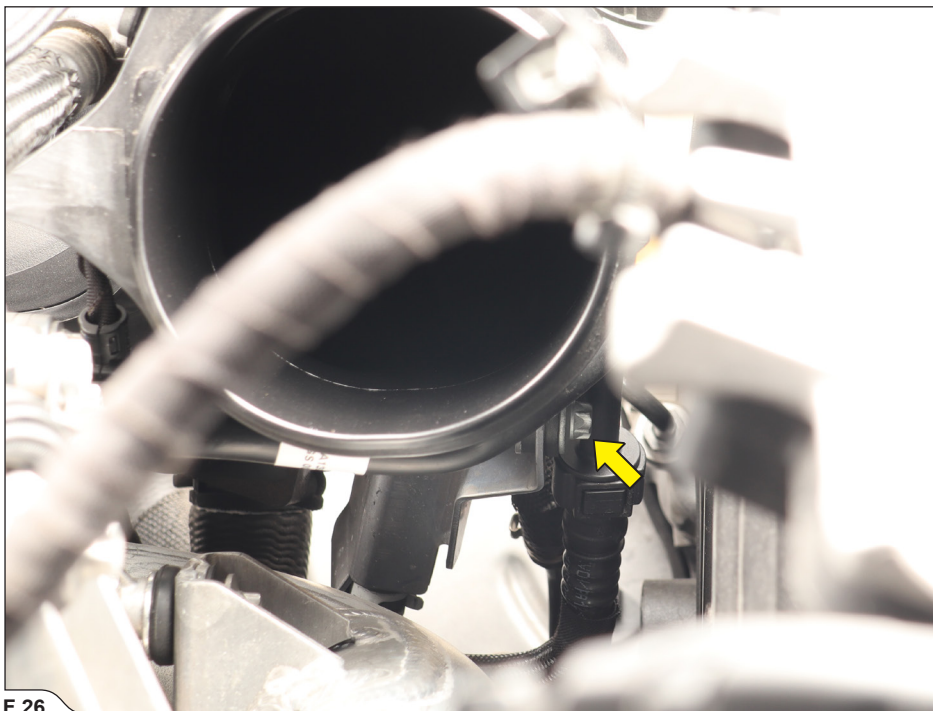

F 26

INSTALLATION OF THE AKRAPOVIČ EXHAUST SYSTEM:

1. **For vehicles with OPF/GPF only:** disassemble the stock sensor as shown, remove the metal and longer rubber tubes, then reinstall the shorter rubber tube as shown, reinstall the sensor onto the bracket (F 27, 28, 29, 30, 31).

! CAUTION: make sure not to injure yourself or damage any part of the vehicle during this process!

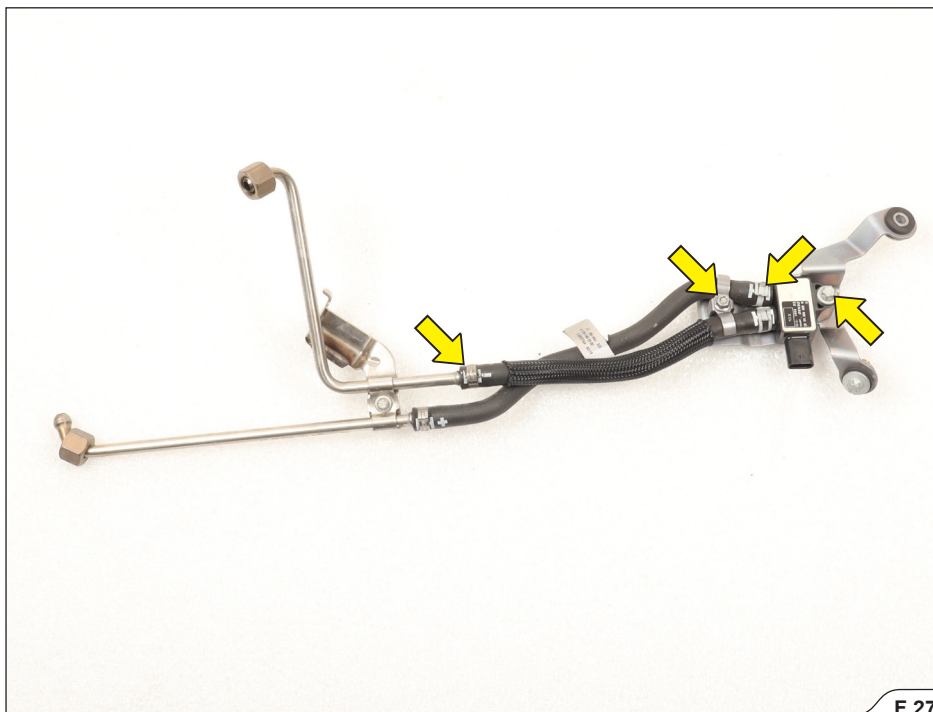

F 27

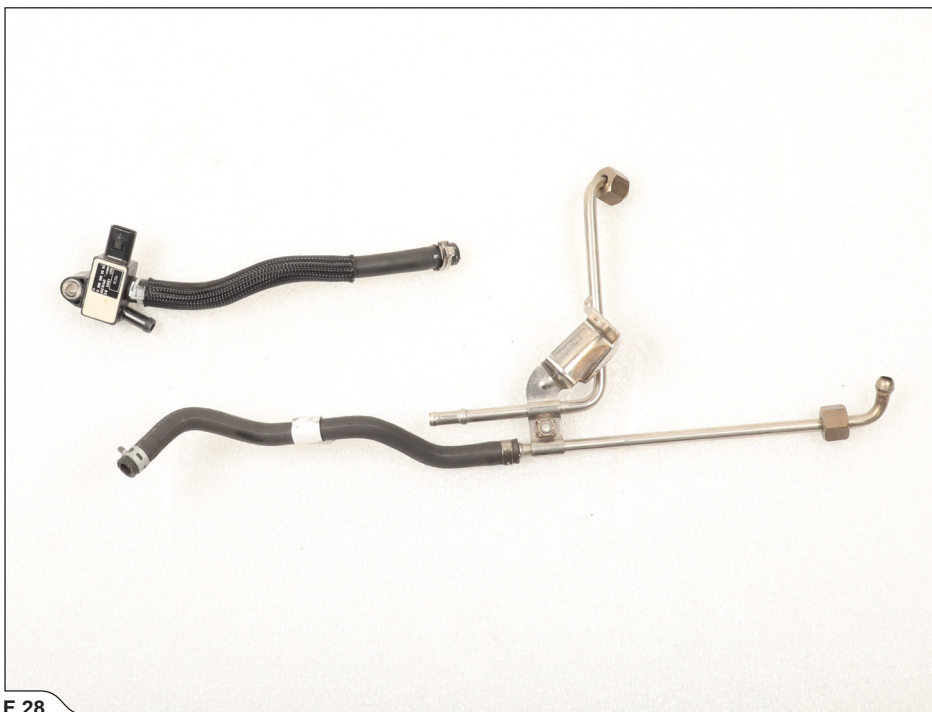

F 28





F 30



2. **For vehicles with OPF/GPF only:** reinstall and reconnect the OPF/GPF sensor as shown, check vehicle manufacturer workshop manual for correct procedures and tightening torques (F 32, 33).

! **CAUTION:** make sure not to injure yourself or damage any part of the vehicle during this process!

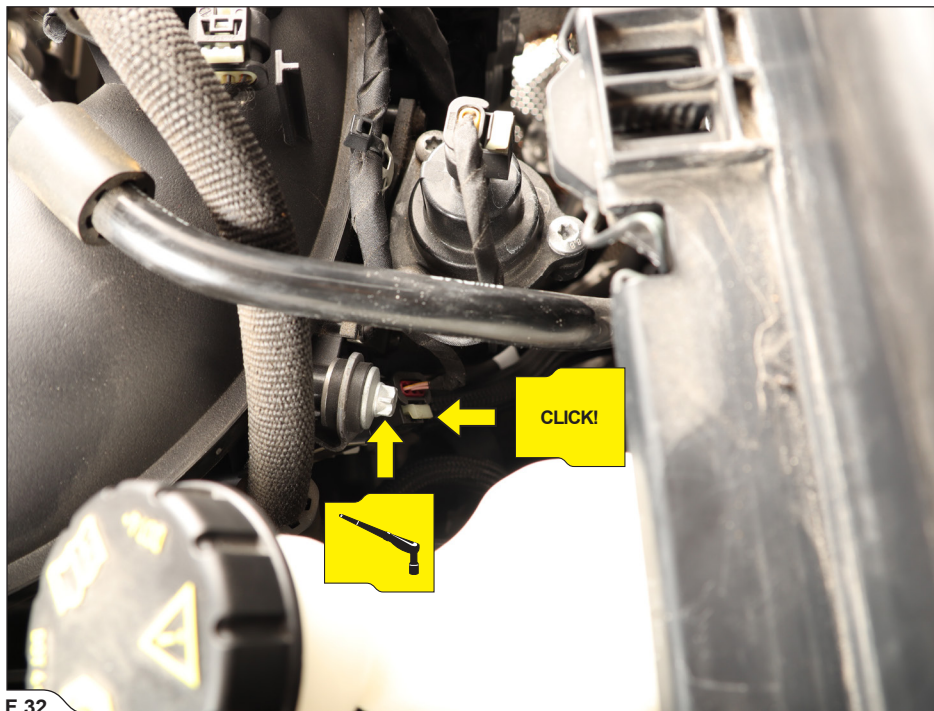

F 32

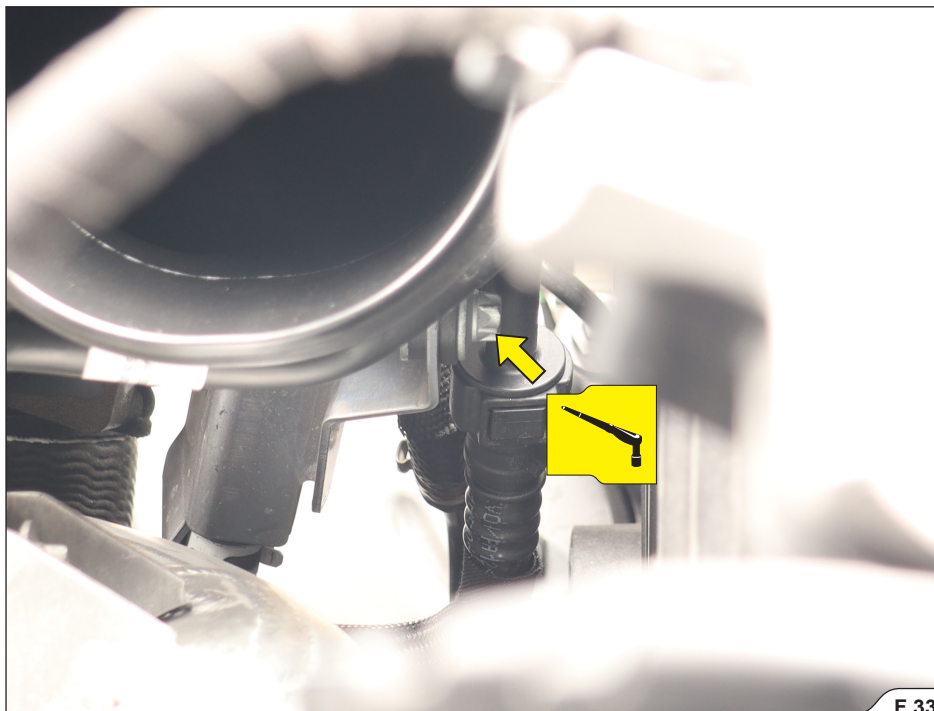

3. Install and hand tighten the stock down pipe's bracket onto Akrapovič down pipe, as shown (F 34, 35).
! CAUTION: make sure not to injure yourself or damage any part of the vehicle during this process!

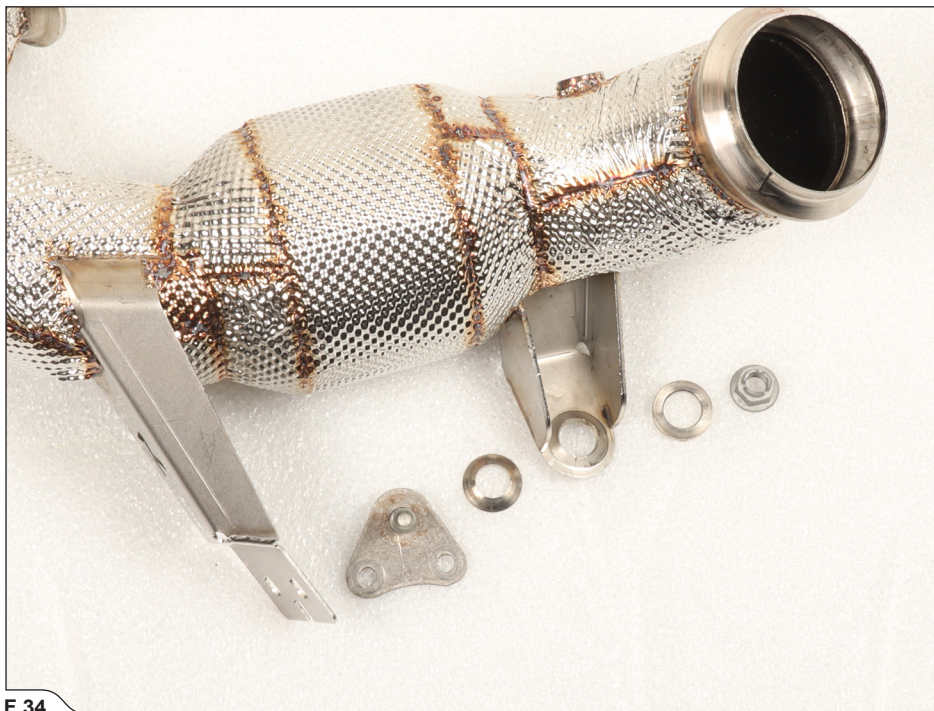

F 34



4. Insert the down pipe into the engine department as shown (F 36).

! **CAUTION:** make sure not to injure yourself or damage any part of the vehicle during this process!



F 36

5. Install the header back onto the engine, tighten the clamp, header nuts and reinstall the locking washers; check vehicle manufacturer workshop manual for correct procedures and tightening torques (F 37, 38, 39).

! **IMPORTANT:** use new stock gasket in turbocharger - header joint.

! **IMPORTANT:** use new stock gasket in engine - header joint.

! **CAUTION:** make sure not to injure yourself or damage any part of the vehicle during this process!

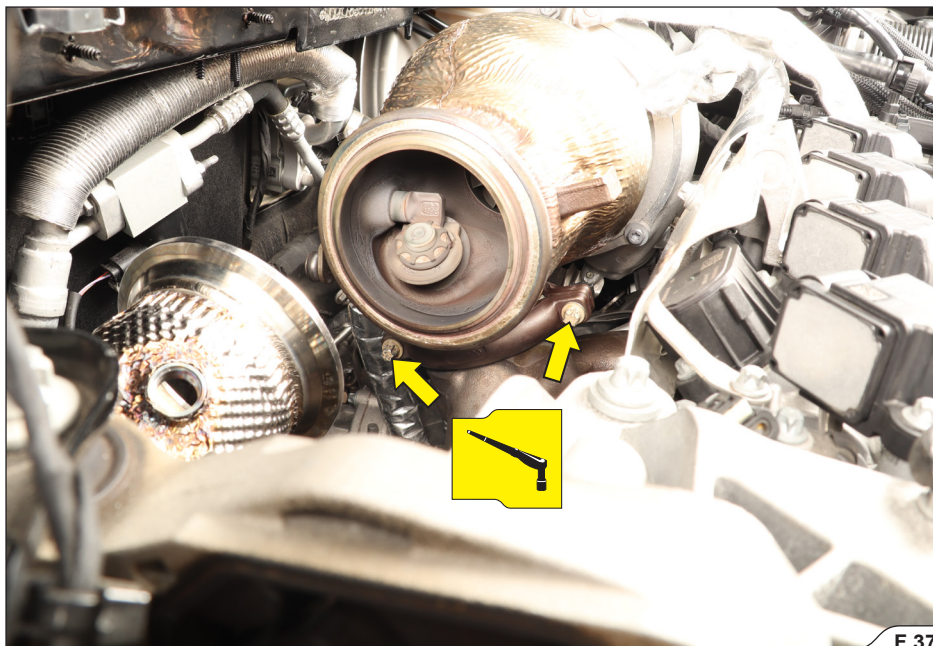

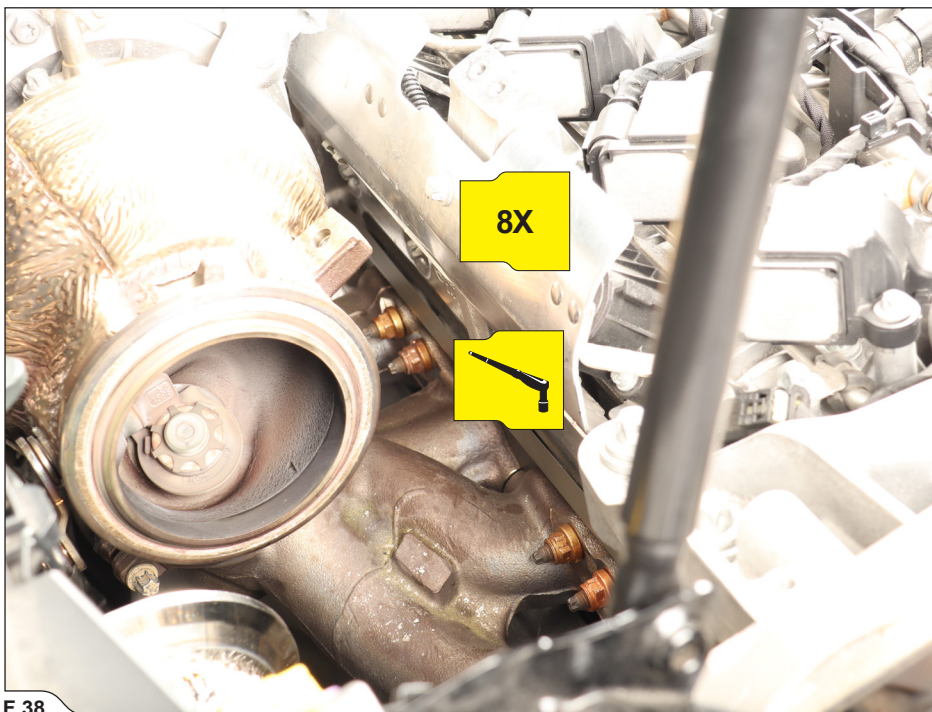

F 38

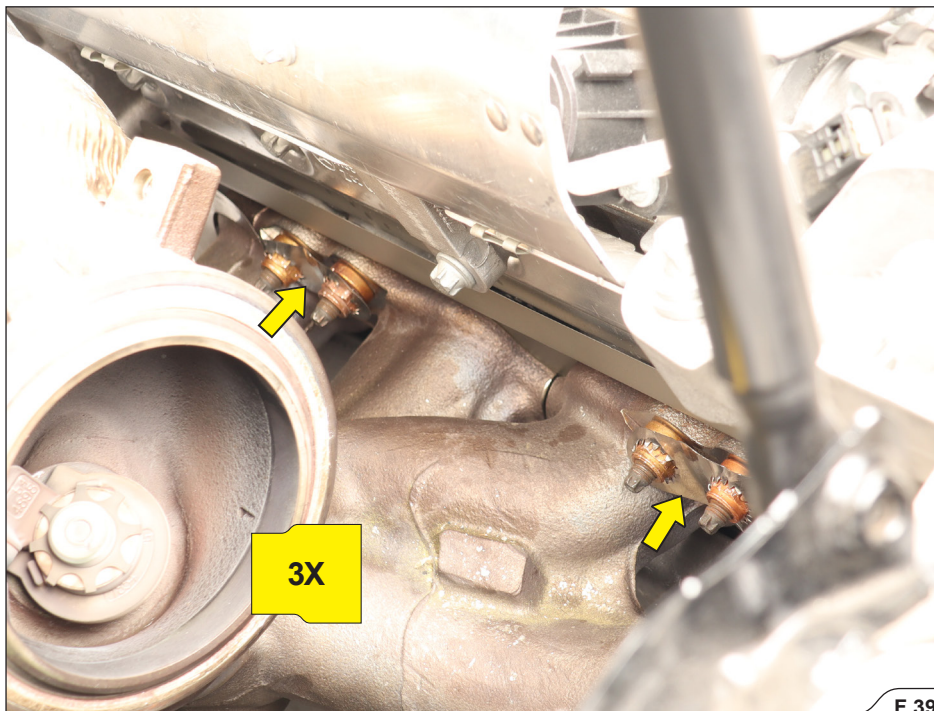

6. Install the downpipe back on the vehicle and hand tightening the clamp, (F 40).

! **IMPORTANT:** use new stock gasket in turbocharger - downpipe joint.

! **CAUTION:** make sure not to injure yourself or damage any part of the vehicle during this process!

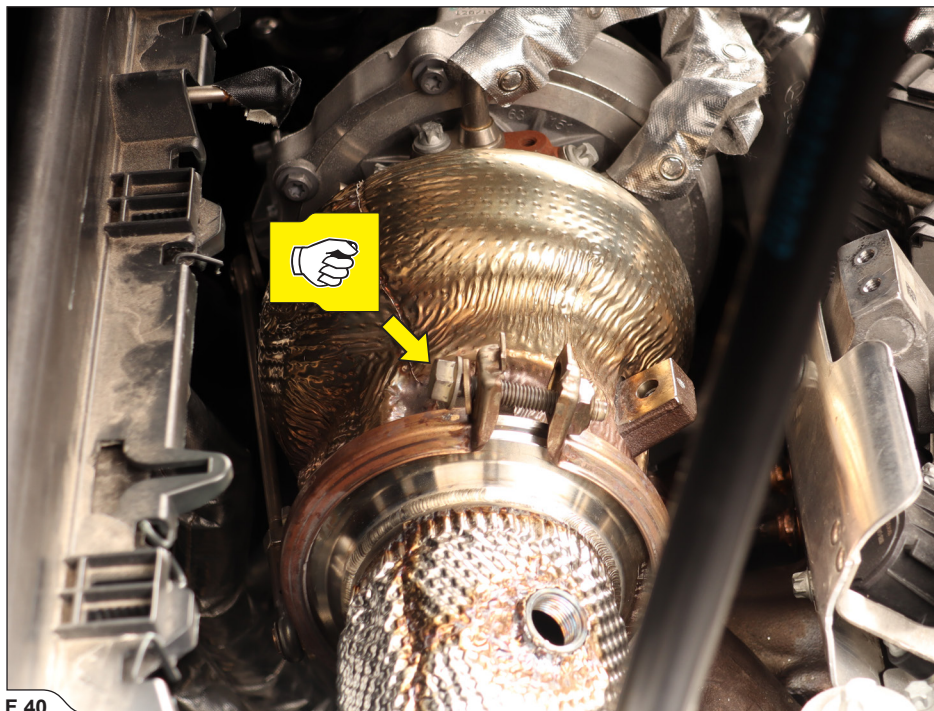

F 40

7. Tighten the downpipe bracket using stock bolts as shown; check vehicle manufacturer workshop manual for correct procedures and tightening torques (**F 41**).

! **CAUTION:** make sure not to injure yourself or damage any part of the vehicle during this process!

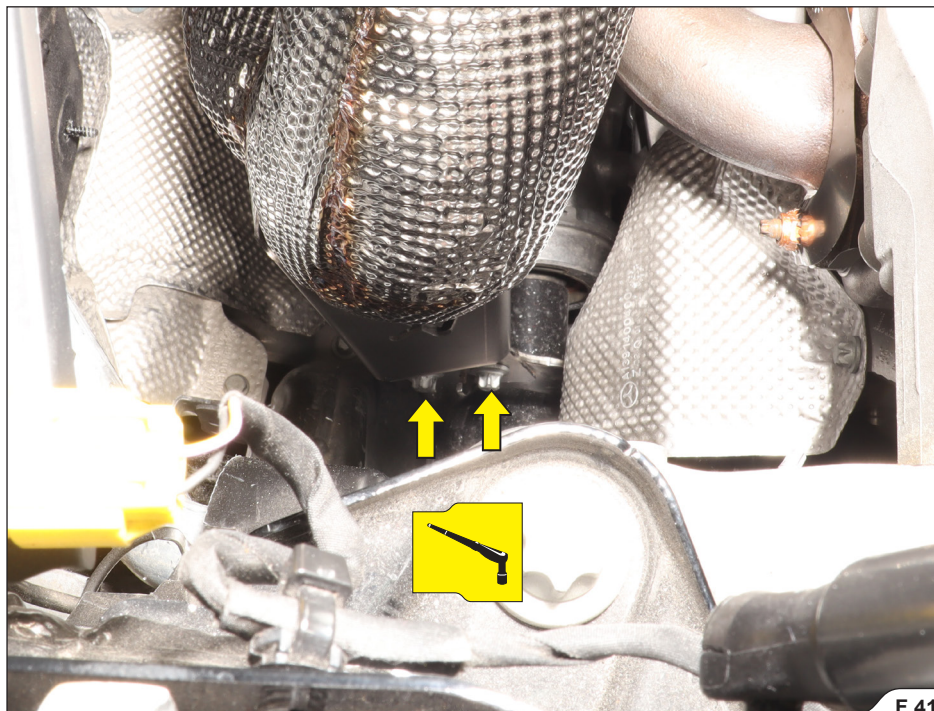

F 41

8. Tighten the down pipes clamp, check the vehicle workshop manual for correct tightening torque (F 42).

! CAUTION: make sure not to injure yourself or damage any part of the vehicle during this process!

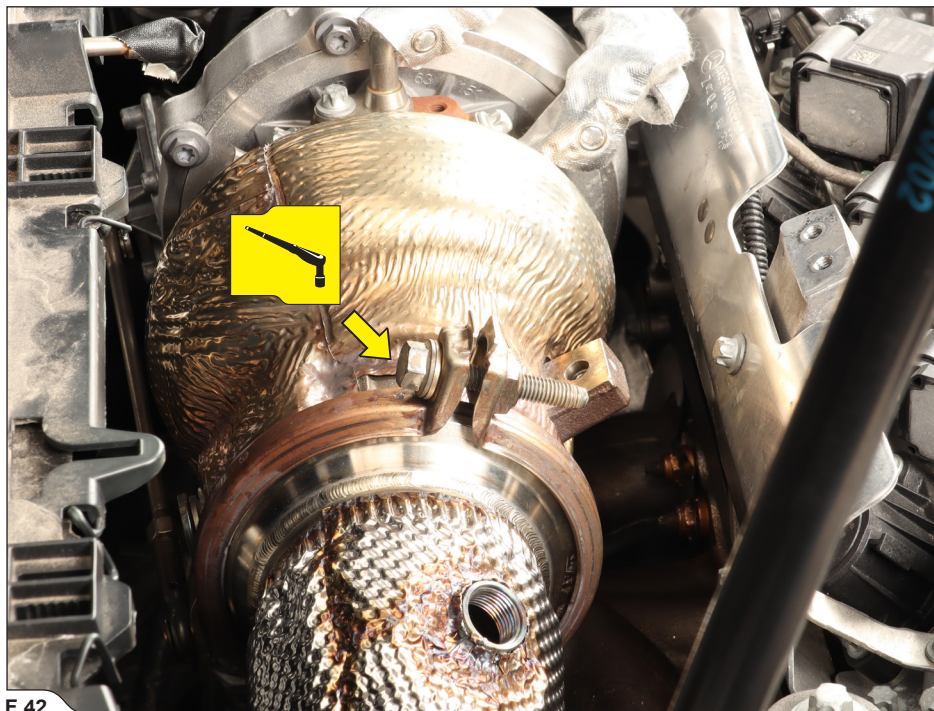

F 42

9. Tighten the stock bracket onto the chassis using stock bolts, than tighten the stock nut onto the Akrapovič down pipe, check the vehicle workshop manual for correct tightening torque (**F 43**).

! **CAUTION:** make sure not to injure yourself or damage any part of the vehicle during this process!

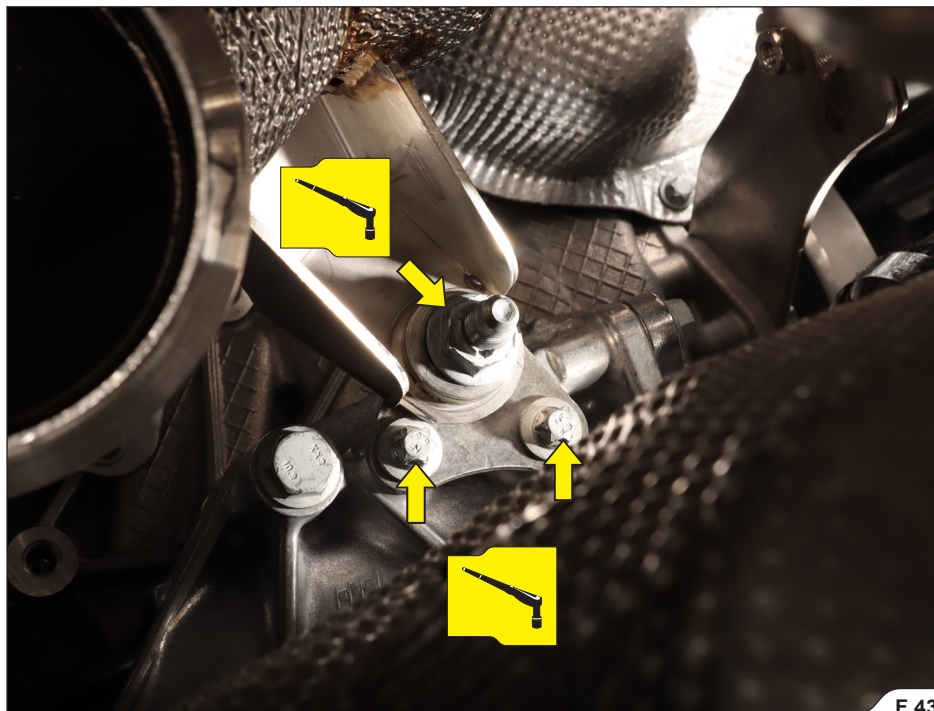

F 43

10. Install lambda sensors into down pipe and tighten them to the specified torque (F 44).

! CAUTION: make sure not to injure yourself or damage any part of the vehicle during this process!

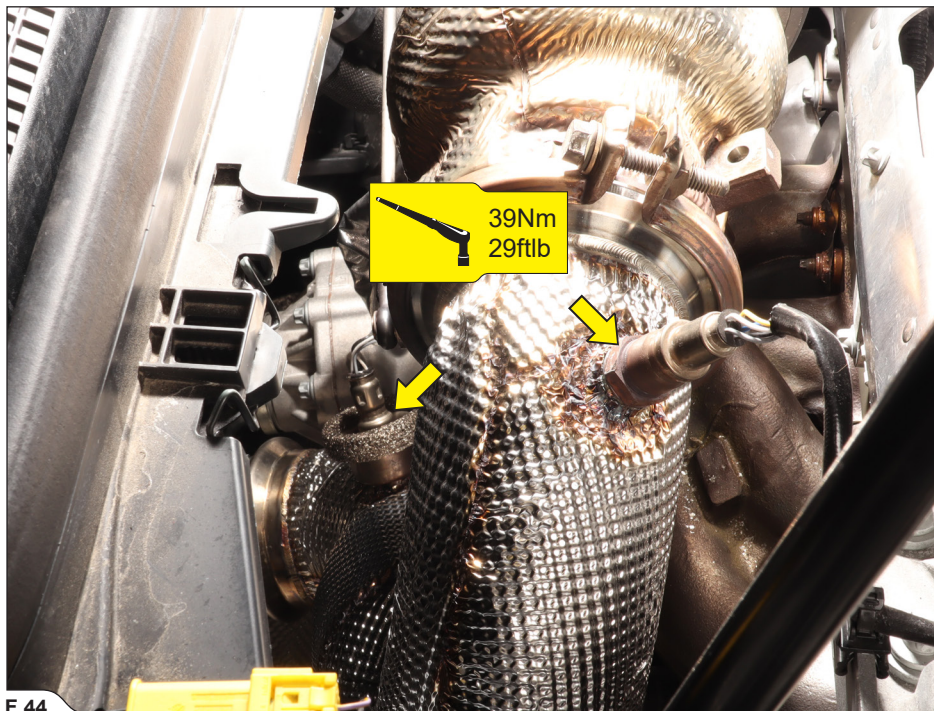

F 44

11. For vehicles with EGT sensors only: reinstall both EGT sensors (F 45, 46).

! CAUTION: make sure not to injure yourself or damage any part of the vehicle during this process!

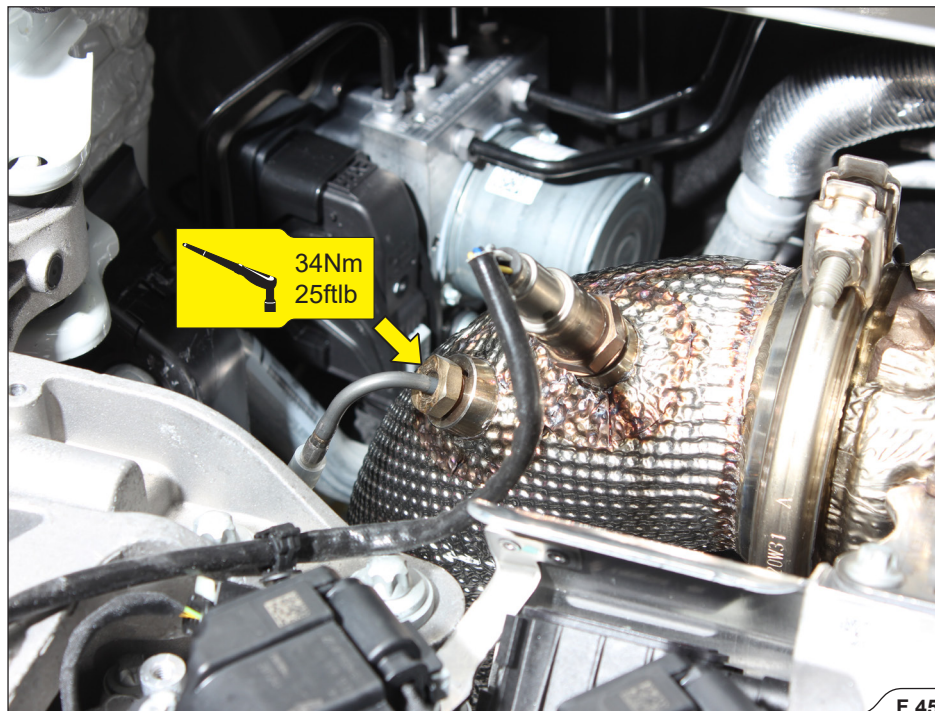

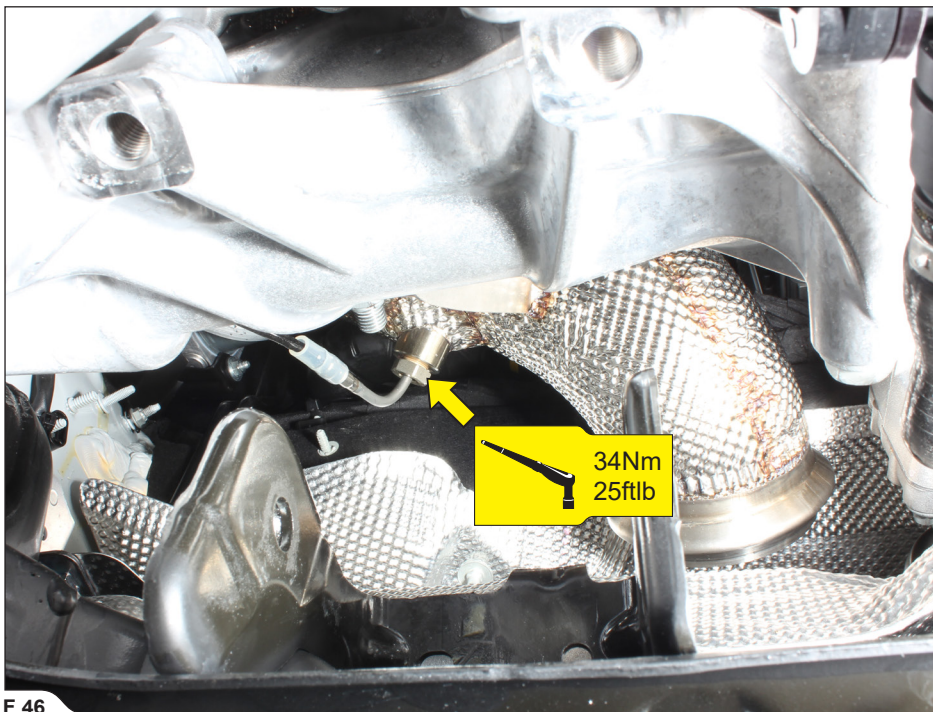

F 46

12. Install the flexible stock pipe on Akrapovič down pipe using stock clamp, check the vehicle workshop manual for correct tightening torque; align the marked spot welds, before tightening (F 47, 48).

! **CAUTION:** make sure not to injure yourself or damage any part of the vehicle during this process!

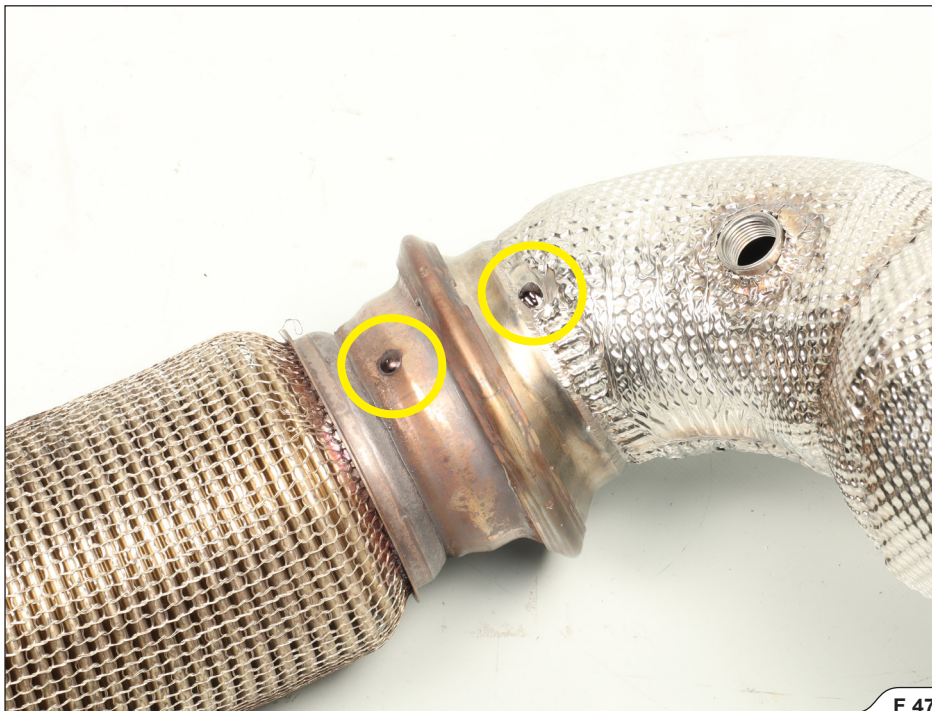

F 47



F 48

13. Reinstall all dismantled stock parts; check vehicle manufacturer manual for correct procedures and tightening torques.

! CAUTION: make sure not to injure yourself or damage any part of the vehicle during this process!

14. Reinstall the Akrapovič EVO system; check the EVO installation manual for details.

! CAUTION: make sure not to injure yourself or damage any part of the vehicle during this process!

FINAL INSTALLATION:

- ! **IMPORTANT:** reinstall the dismantled or partially removed stock parts (wheel arches, bumper etc.); check vehicle manufacturer workshop manual for correct procedures and tightening torques.
- ! **IMPORTANT:** make sure all the nuts and bolts are sufficiently tightened. In case the Akrapovič product touches the cowling or other parts, repeat the adjustment of the product or contact your authorized dealer.
- ! **IMPORTANT:** clean all Akrapovič product's surfaces before the first start of the engine or the stains will burn onto the surfaces!

MAINTENANCE OF THE AKRAPOVIČ PRODUCT:

1. Clean all Akrapovič product's surfaces. Cleaning will prevent spots from burning onto the surface. Do not use aggressive chemical cleaners, because they can damage the surface:
 - **Titanium surfaces** (titanium muffler's outer sleeve, titanium pipes etc): use a soft cloth sprayed with a multi-purpose spray lubricant (WD-40® or equivalent)*, then wipe with a soft dry cloth.
 - **Carbon-fiber surfaces** (carbon-fiber outlet cap, carbon-fiber muffler's outer sleeve, carbon-fiber bracket etc): use a soft dry cloth sprayed with all purpose foam cleaner, then wipe with a soft dry cloth.
 - **Painted surfaces** (painted outlet cap, painted muffler's outer sleeve, painted bracket etc): use a soft cloth sprayed with all purpose foam cleaner, then wipe with a soft dry cloth.
 - **Chrome plated surfaces** (chrome plated outlet cap, chrome plated muffler's outer sleeve etc): use a soft cloth sprayed with all purpose foam cleaner, then wipe with a soft dry cloth.
 - **Stainless steel surfaces** (stainless steel muffler's outer sleeve, stainless steel pipes etc): use a soft cloth sprayed with a contact cleaner, then wipe with a soft dry cloth.

*WD-40® is a trademark of the WD-40 Company.

2. Periodically check if all the Akrapovič product's nuts and bolts are sufficiently tightened.

- ! **IMPORTANT: IT IS NORMAL FOR WHITE SMOKE TO COME OUT OF THE MUFFLER AT FIRST OPERATION.**
- ! **CAUTION: DO NOT STAND BEHIND THE MUFFLER AT ANY TIME.**
- ! **IMPORTANT: DO NOT USE AUTOMOTIVE WHEEL CLEANERS OR ANY CLEANING PRODUCTS WHICH CONTAIN ACIDIC ADDITIVES TO CLEAN THE AKRAPOVIČ EXHAUST SYSTEMS.**
- ! **IMPORTANT: WE RECOMMEND HIGH CAUTION WHEN USING POWER / PRESSURE WASHER FOR CLEANING PAINTED / LACQUERED SURFACES OF THE AKRAPOVIČ COMPONENTS, TO AVOID PAINT / LACQUER DAMAGE.**
- ! **IMPORTANT: SOME OF THE AKRAPOVIČ CARBON FIBER COMPONENTS ARE ADDITIONALLY PROTECTED AGAINST ROCK CHIPS WITH CLEAR LACQUER PROTECTION FILM. THE PROTECTION FILM IS AVAILABLE AS SPARE PART BY AKRAPOVIČ COMPANY. THE PROTECTION FILM IS NOT THE SUBJECT OF THE AKRAPOVIČ WARRANTY.**
- ! **IMPORTANT: ALL AKRAPOVIČ PRODUCTS ARE DEVELOPED AND DESIGNED TO BE USED ON SPECIFIC VEHICLES, FOR THEIR ENTIRE EXPECTED LIFETIME. PLEASE MAKE SURE THAT END-OF-LIFE AKRAPOVIČ PRODUCT IS DISASSEMBLED TO COMPONENTS SHOWN IN THE PRODUCT'S SCHEMATIC DIAGRAM AVAILABLE ON THE AKRAPOVIČ WEBSITE AND EACH COMPONENT SCRAPPED RESPONSIBLY AND ACCORDING TO APPLICABLE LOCAL LAWS AND REGULATIONS. AKRAPOVIČ DOES NOT ASSUME ANY OBLIGATION OR RESPONSIBILITY WITH RESPECT TO THE SCRAPPING PROCESS OR PROVIDING INFORMATION RELATED THERETO.**
- ! **CAUTION: THE EXHAUST SYSTEM CAN BE EXTREMELY HOT. ALLOW THE EXHAUST AND ENGINE TO COOL DOWN BEFORE BEGINNING INSTALLATION OR ANY OTHER WORK ON THE EXHAUST SYSTEM. THIS MANUAL IS SPECIFIC TO THE MERCEDES-A45 TYPE (W177) / CLA45 (X118/C118). THERE MAY BE SOME DIFFERENCES IN INSTALLATION PROCEDURES FOR OTHER MODELS.**

TROUBLESHOOTING:

Problem	Possible cause	Solution
Exhaust gas leaks out of the down-pipe/flexible pipe clamp connections	loosened clamp	tighten the clamp to specified torque
	connection is not completely joined	tap the connection into place and tighten the clamp to specified torque

www.akrapovic.com

