



Installation instructions

Akrapovič Exhaust System:
Evolution line
for the
Porsche Cayenne (type 536)

ENGLISH
Version 1.0

10/2019



www.akrapovic.com



Installation instructions

Akrapovič Exhaust System:
Evolution line
for the
Porsche Cayenne (type 536)

ENGLISH
Version 1.0

10/2019

www.akrapovic.com

Congratulations on purchasing the Akrapovič exhaust system. The Akrapovič exhaust system is a product of Akrapovič d.d., Malo Hudo 8a, 1295 Ivančna Gorica, Slovenia ("Akrapovič").

Please read this entire installation manual carefully prior to installing and using the Akrapovič exhaust system.

Akrapovič exhaust system should only be installed by persons skilled in car exhaust system installation and performance. The instructions provided in this manual should be followed to ensure proper installation and safe use of the Akrapovič exhaust system. Akrapovič and/or its partners shall not be held liable for any damage or personal injury (including direct, indirect, or consequential damage) sustained as a result of improper installation of the Akrapovič exhaust system or its use and maintenance contrary to the instructions and warnings contained herein.

If you have any questions regarding the installation and/or proper use of the Akrapovič exhaust system or this manual, please contact your local Akrapovič partner.

For more information on the Akrapovič exhaust systems, see the official Akrapovič website at: <http://www.akrapovic.com>

GENERAL INFORMATION

Your safety is our number one priority. Please drive your car responsibly, safely and always obey local traffic rules.

All statements made with regard to the exhaust system's compliance are made in respect of the exhaust system "as is". Any modifications of the Akrapovič exhaust system or its improper installation, use or maintenance that is not in accordance with this Installation manual, may result in severe damage to the exhaust system and/ or engine, as well as personal injury, and may affect the exhaust system's compliance with the legal requirements, such as exhaust system's air and/ or noise emissions (as an example, the car may not be suitable for use on public roads any longer), as well as warranty coverage.

The exhaust system may only be used in accordance with relevant laws and regulations, including state and federal, where applicable.

Damage caused by improper installation, use and maintenance of the Akrapovič exhaust system is not covered by the Akrapovič warranty. Please refer to the enclosed warranty with regard to the terms of our warranty.

Technical specifications of Akrapovič exhaust systems and related products are subject to change without notice.

COPYRIGHT AND OTHER RIGHTS NOTICE

The Akrapovič trademark, including corporate logos and emblems, are subject to copyright as well as trademark rights of Akrapovič, its licensors, or third persons authorizing Akrapovič to use them.

Any reproduction, technical or other manipulation, translation, or other use of the copyright and/or trademark rights contained herein is prohibited without the explicit prior written consent of Akrapovič. The same especially applies to the entire contents of this manual and/or any of its parts, including but not limited to technical specifications, instructions, graphs, photographs, and so on included in this manual.

Akrapovič takes all copyright and other rights infringement cases under serious consideration. If you have any reason to believe that your exhaust system is not an original Akrapovič product, please contact our local partners or Akrapovič at info@akrapovic.com.

SAFETY AND COMPLIANCE WARNING, PLEASE READ CAREFULLY

BEFORE REMOVING THE STOCK EXHAUST SYSTEM AND BEGINNING THE INSTALLATION OF YOUR NEW AKRAPOVIČ EXHAUST, PLEASE MAKE SURE THAT ALL ITEMS LISTED BELOW ARE VERIFIED:

- This manual is specific to the car indicated on the cover page, for which it is designed. Installation procedures vary depending on the type of car. Please verify that the Akrapovič **exhaust system and this installation manual correspond to the type of your car.**
- The exhaust system can get extremely hot during and after it is used. Make sure not to touch the exhaust system until it is completely cool. **Allow the exhaust and engine to cool down before beginning installation.**
- Make sure the car is **securely positioned to prevent** damage to yourself and other, or the car.
- Please check the parts you received against the parts list available on our website (please use the QR code on the front page or look for “schematic view” in the respective product page on www.akrapovic.com). Make sure that you have **all the parts necessary for the installation** of your new Akrapovič exhaust system. If any of the parts is missing, please do not proceed with uninstalling your stock exhaust system/installing the Akrapovič exhaust system and contact the retailer where you purchased the Akrapovič exhaust system.
- Every exhaust system muffler has its unique serial number, which identifies the authenticity of the product. You can find the serial number on the muffler’s sleeve. Please refer to the **picture 1** below. Please verify that your exhaust system is an original Akrapovič product. If you have any doubts, please contact the reseller where you purchased the exhaust system or Akrapovič partners. This manual, any certificates and Akrapovič warranty apply to original products only.

GENERAL NOTE

Photographs and other illustrations in this manual are symbolic and are intended to help represent individual steps for proper installation and use, as well as for a general overview. The actual component parts of the Akrapovič exhaust system may not entirely correspond to the photographs and other illustrations.

Picture 1 - Serial Number Position

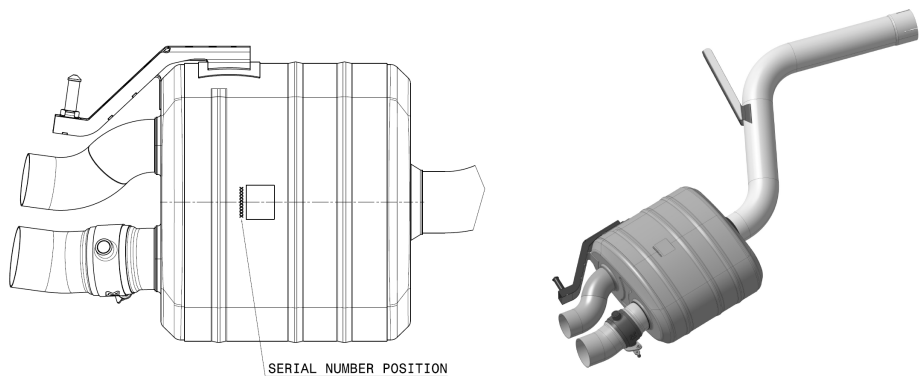

NOISE AND EMISSION WARNINGS

General warning

Because of the world-wide distribution of Akrapovič d.d. products, neither Akrapovič d.d. nor any of its subsidiaries make any representation that the exhaust system complies with the air and/or noise emissions laws, or labeling laws, of any jurisdiction. The purchasers are entirely responsible for informing themselves of the applicable laws where the products are to be used and to comply with those law.

Although legal compliance of Akrapovič products in a specific country should be determined by the user, you can find some basic guidance on compliance of your Akrapovič exhaust system with various legal requirements on the product-related part of our website (please use the QR code on the front page or look for the respective product page on www.akrapovic.com). For EC and ECE type approvals, please refer to the certificate enclosed to your product.

USA WARNING

Various U.S. states and the U.S. federal government have individual laws regulating the use of aftermarket exhaust parts and systems, especially as those parts and systems modify, remove, or replace original equipment catalysts. Please consult the appropriate laws in your area before installing any aftermarket part or system on your vehicle to ensure compliance with all applicable laws. Neither Akrapovic d.d. nor any of their subsidiaries or the sellers of the parts or systems make any representation that any of their parts or systems comply with any such laws.

CALIFORNIA WARNING

California laws prohibit the use of any aftermarket exhaust part or system that modifies, removes or replaces original equipment catalysts unless the California Air Resources Board has issued an Executive Order regarding such part or system or unless the part or system is exempted by being used only on racing vehicles on closed courses. Neither Akrapovic d.d. nor any of their subsidiaries make any representation that any of their parts or systems has received such an Executive Order or that any of their parts or systems conform with the racing vehicles exemption. The purchasers are entirely responsible for informing themselves of applicable California laws and to comply with those laws.

SYMBOLS

The following symbols are used throughout these installation instructions:



**TOOLS AND PROTECTIVE
EQUIPMENT REQUIRED**



TIGHTENING TORQUE



LUBRICATION



HAND TIGHTEN



INSTALLATION TIP



CAUTION OR IMPORTANT

USE BOLT SEALANT

Apply 3 to 4 small drops of bolt sealant onto the cleaned and degreased threads before tightening the bolts.

WARNING! Avoid contact with skin, eyes and mucous membranes. Do not inhale fumes. Keep out of reach of children.



USE ANTI-SEIZE LEAD-FREE COPPER PASTE (black tube)

Provides trouble-free and long-lasting protection against seizing, corrosion and rusting of bolts, threaded ends, nuts, joints, etc. Also protects against vibration, wear and impact. **WARNING! Avoid eye contact. Keep out of reach of children.**



USE ANTI-SEIZING GREASE (white tube)

Prevents seizing, corrosion and excessive wear between the titanium components of your exhaust system. **WARNING! Avoid eye contact. Keep out of reach of children.**



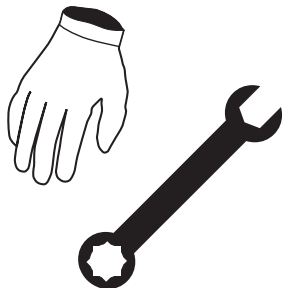

Tools & equipment

- mechanic gloves
- eye protection
- Torx 30
- Torx E12
- Torx XZN 8
- Socket 15 mm
- Socket 16 mm
- Socket 17 mm
- T-handle 10 mm wrench
- T-handle 13 mm swivelling wrench
- T-handle 6 mm three hexagon wrench
- Rubber bracket unhooking tool
- Small cross head screwdriver
- Cutting nippers

PARTS LIST

The following parts should be found in the box:

- Installation Manual
- Homologation certificate/ compliance documents if applicable
- Warranty
- Fitting material
- Muffler, pipes, Carbon Fiber components or Sound Kit components

Detailed list of parts can be found on the Akrapovič website (please use the QR code on the front page or look for "Schematic view" in the respective product page on www.akrapovic.com).

IMPORTANT: The car should be in the off position throughout the dismantling and installation process, as well as any other work done on the exhaust system!

REMOVAL OF STOCK EXHAUST SYSTEM:

The process of uninstalling the original exhaust system may vary depending on the existing exhaust system. Please follow the original exhaust system manufacturer's instructions for uninstalling the original exhaust system.

If you for any reason decide otherwise, please note that any information provided in this respect herein should be considered as general information provided for your convenience only. Akrapovič shall not assume any liability or responsibility with regard to uninstalling your existing exhaust system, warranty coverage of such exhaust system or vehicle or their further fitness for use.

In case your Akrapovič exhaust system may not be used on certain roads or under certain conditions, please keep the stock or other exhaust system that you can use in such circumstances legally.

REMOVAL OF STOCK EXHAUST SYSTEM:

Put the vehicle onto a car lift.

! **CAUTION:** ensure that the car is lifted safely and properly in order to avoid the risk of vehicle damage, injury, or even death!

1. Unscrew the marked bolts and carefully remove the panels on both sides of the vehicle (F 01, 02).

! **CAUTION:** make sure not to injure yourself or damage any part of the vehicle during this process!

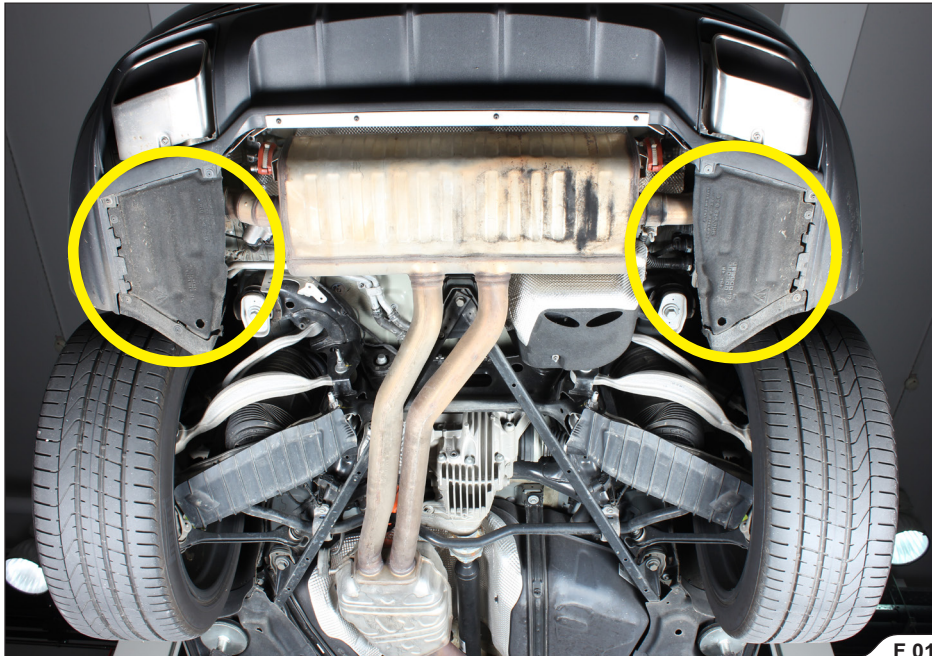

F 01

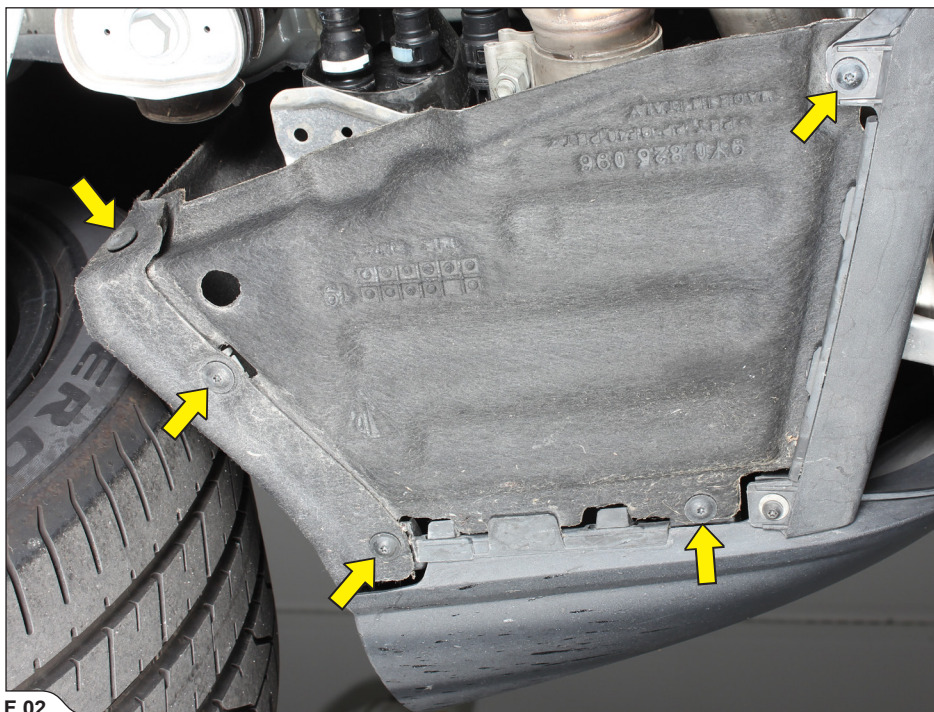

F 02

2. Loosen the marked clamps on both sides of the vehicle and carefully remove the tail pipes (F 03).
! CAUTION: make sure not to injure yourself or damage any part of the vehicle during this process!

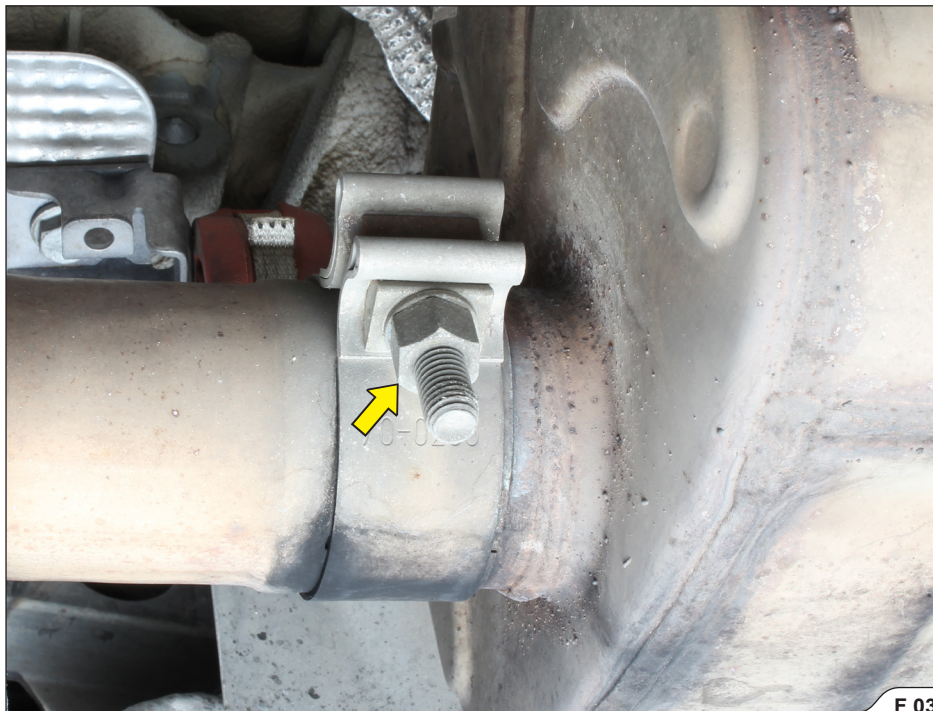

F 03

3. Mark the stock exhaust system, exactly as shown. Carefully cut the pipe at the marked cutting line, using pipe cutting tool or equivalent (F 04, 05).

! **CAUTION:** make sure not to injure yourself or damage any part of the vehicle during this process!

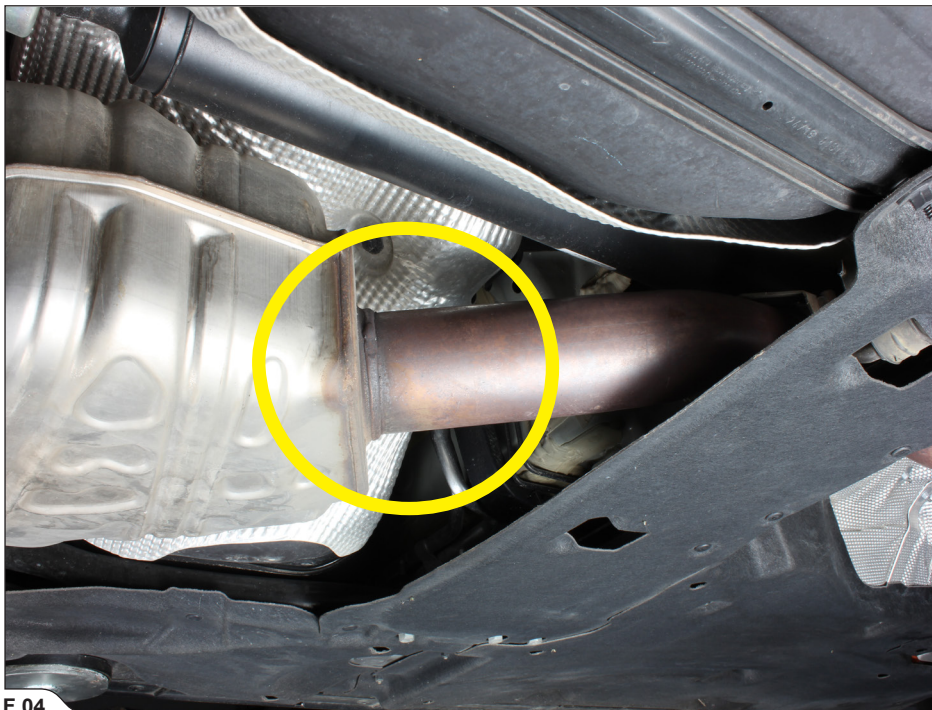

F 04

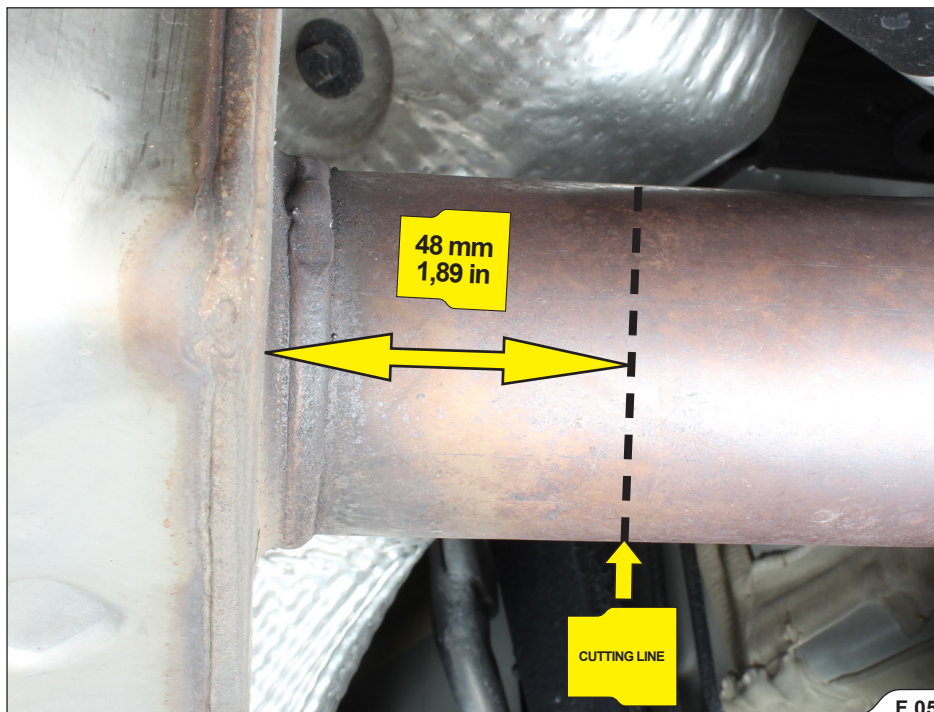

4. For vehicles WITH stock exhaust flap(s) only: disconnect the exhaust flap actuator(s) (F 06).
! CAUTION: make sure not to injure yourself or damage any part of the vehicle during this process!



F 06

5. Support the exhaust system, undo the middle rubber bracket, unscrew both muffler's rubber brackets and carefully remove the system off the vehicle (F 07, 08, 09).

! INSTALLATION TIP: for easier dismounting, lubricate the original rubber bracket (WD40®)*.

*WD-40® is a trademark of the WD-40 Company.

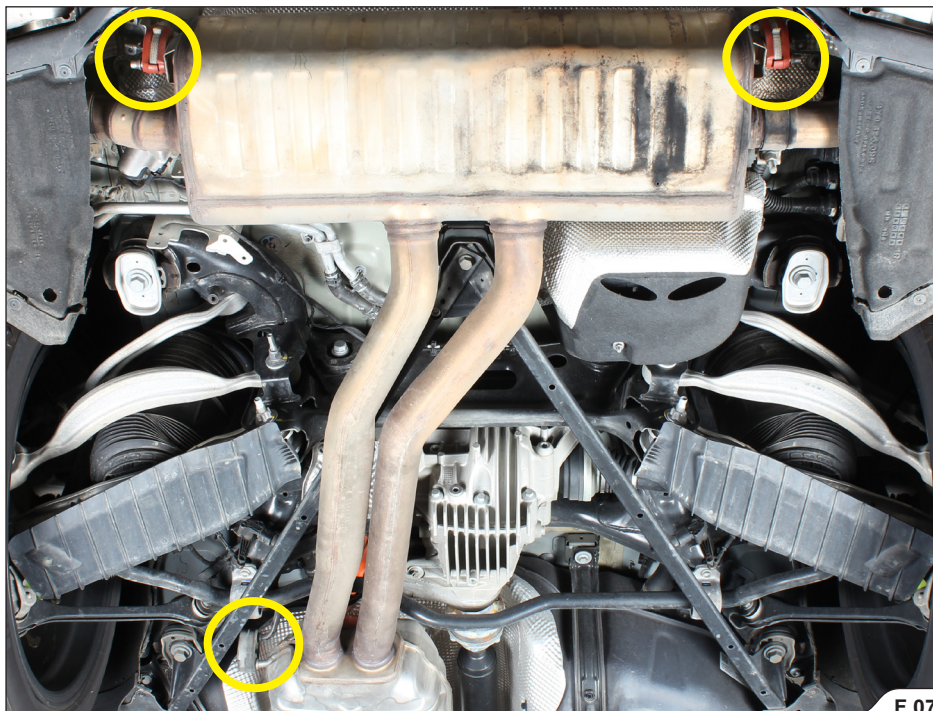

F 07

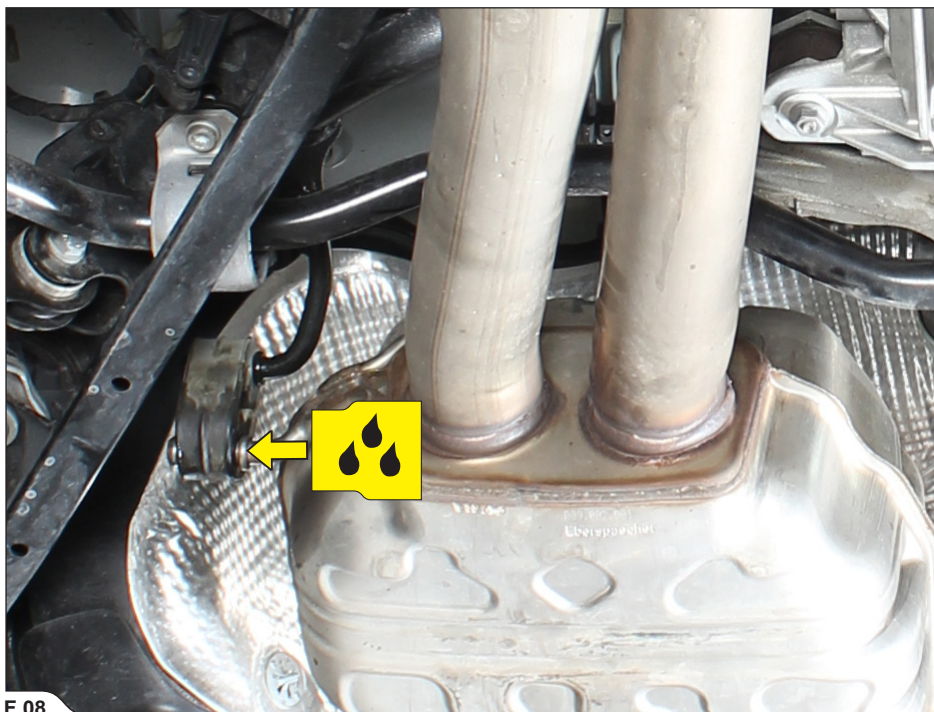

F 08

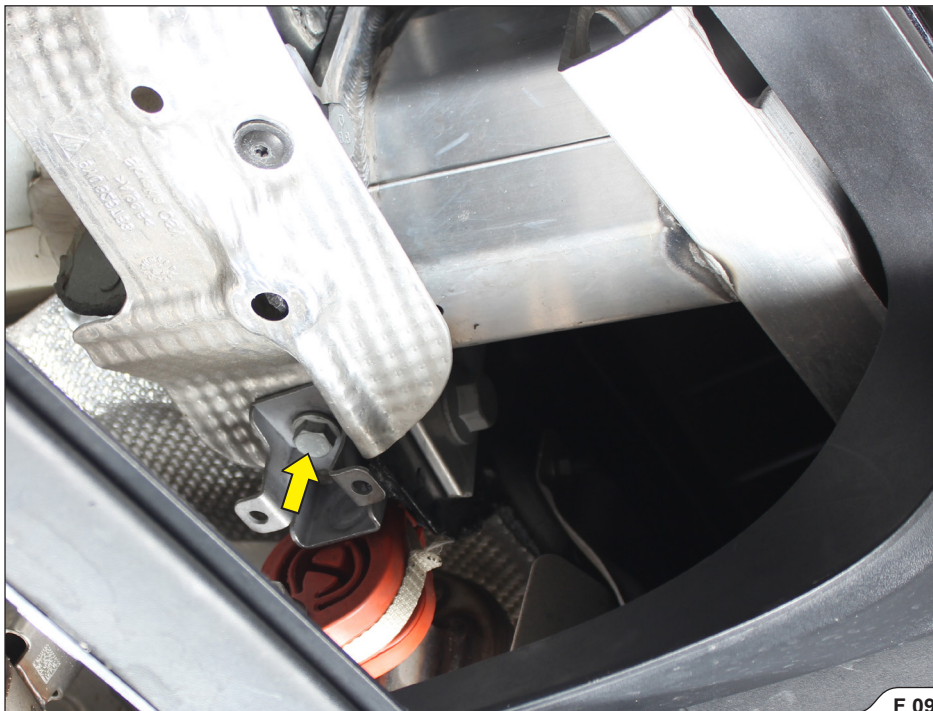

6. Unscrew the marked nuts and remove the muffler's heat shield off the vehicle (F 10).

! CAUTION: make sure not to injure yourself or damage any part of the vehicle during this process!

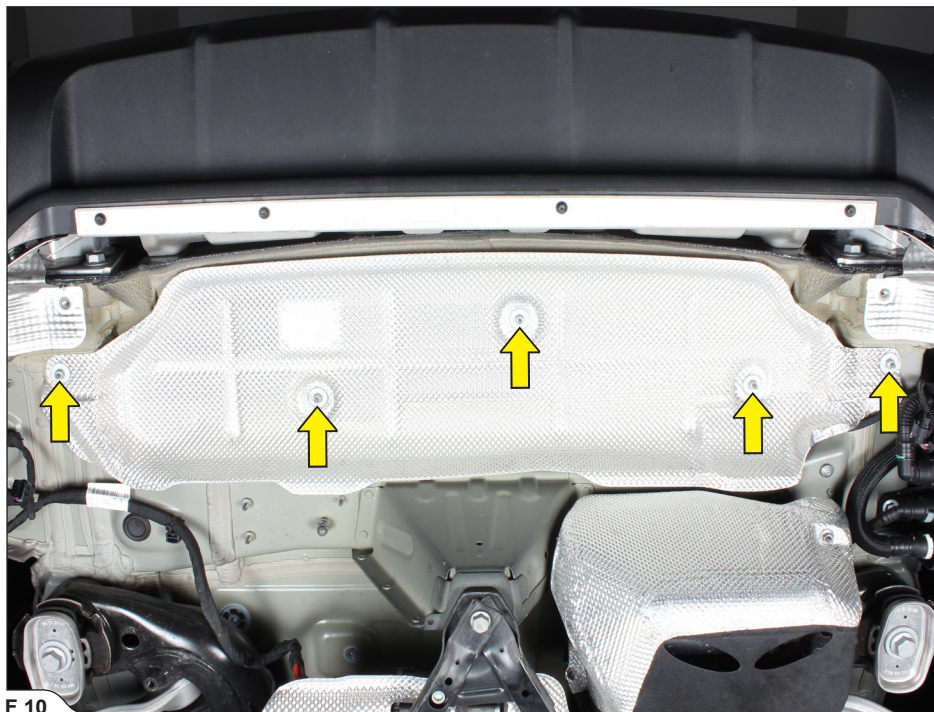

F 10

7. Remove the marked rubber grommet (F 11).

! CAUTION: make sure not to injure yourself or damage any part of the vehicle during this process!

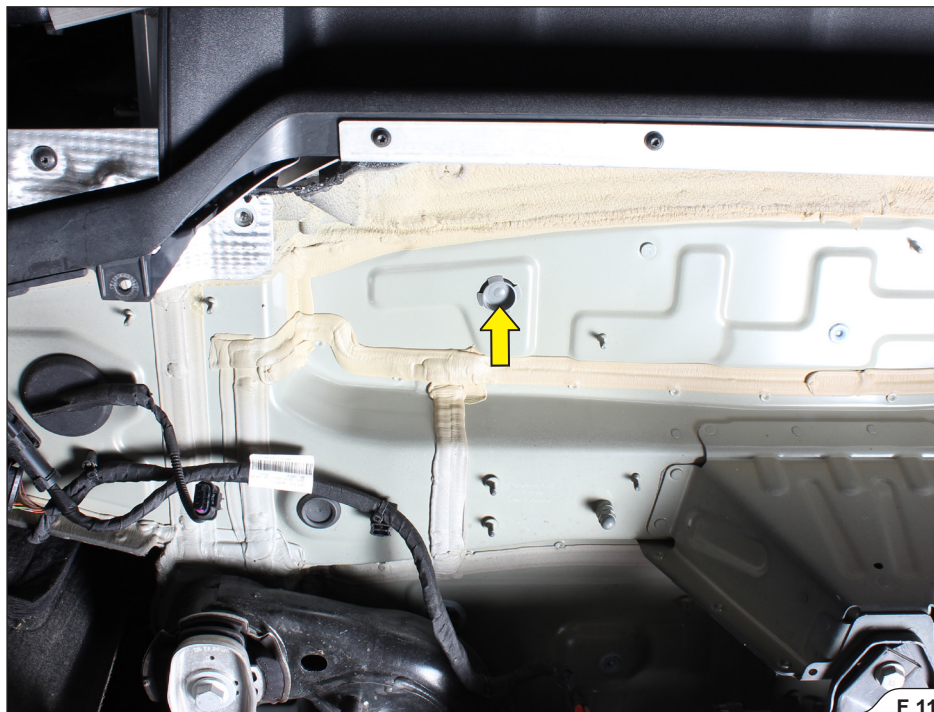

F 11

INSTALLATION OF THE AKRAPOVIČ EXHAUST SYSTEM:

1. Open the trunk, remove the trunk floor panel and left side trunk trim panels to get access to electrical wiring harness in the trunk; check vehicle manufacturer manual for correct trunk panels disassembly (F 12, 13, 14, 15, 16).

! CAUTION: make sure not to injure yourself or damage any part of the vehicle during this process!



F 12

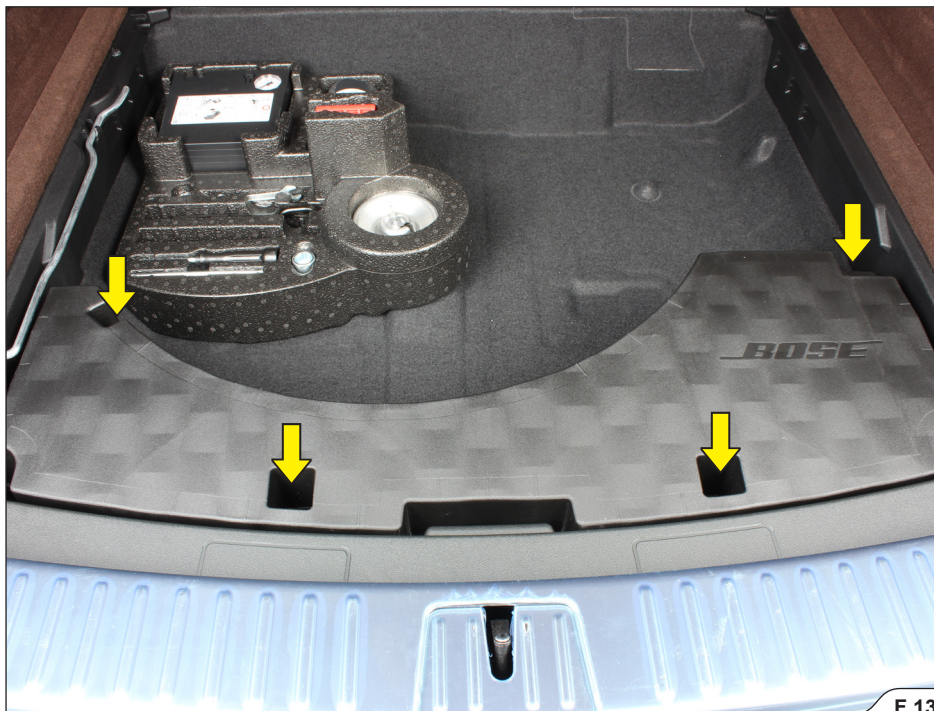

F 13



F 14



F 15



F 16

- Carefully separate the marked **green** and **orange** wires from the stock harness - located on the left side of the trunk (F 17, 18).

! **IMPORTANT:** make sure not to damage the wires during this process!



F 17

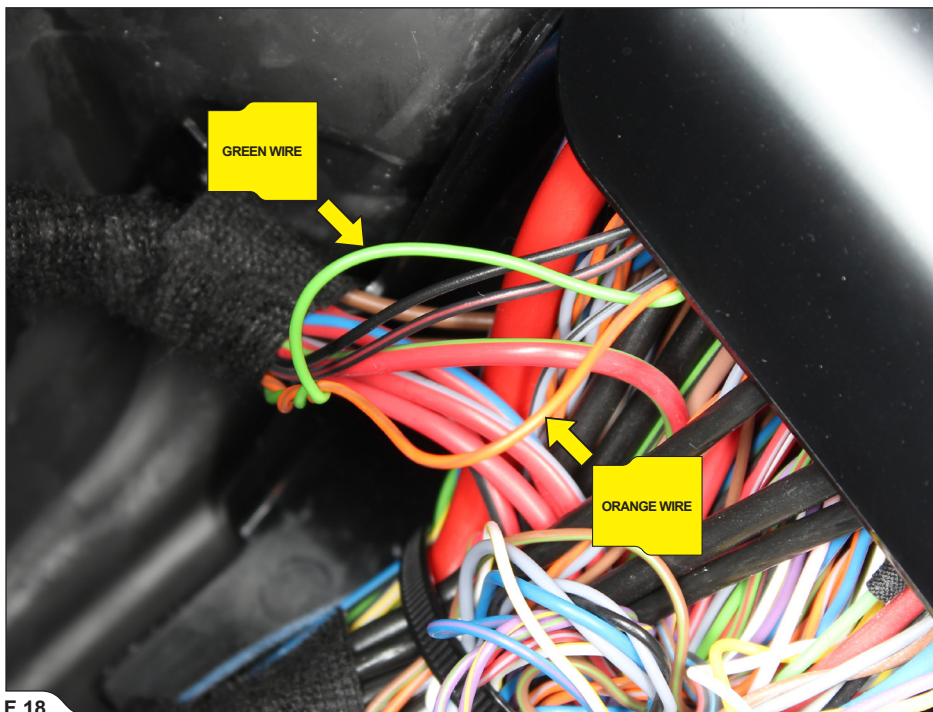

F 18

3. The Sound Kit components (F 19, 20, 21, 22, 23):

- | | | |
|-----------------------------|-----------------------------------|----------------------------------|
| 1 - Control kit | 4 - To right flap actuator | 7 - To left stock flap connector |
| 2 - CAN sniffer | 5 - To right stock flap connector | 8 - 3p to 4p adapters |
| 3 - Power supply connectors | 6 - To left flap actuator | 9 - Connector plugs |

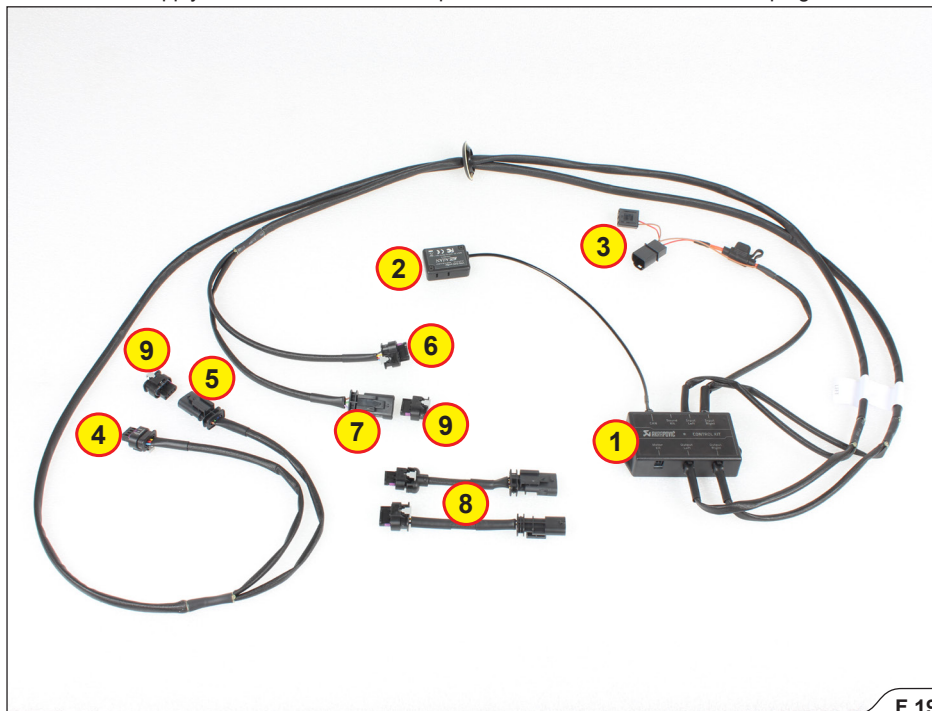

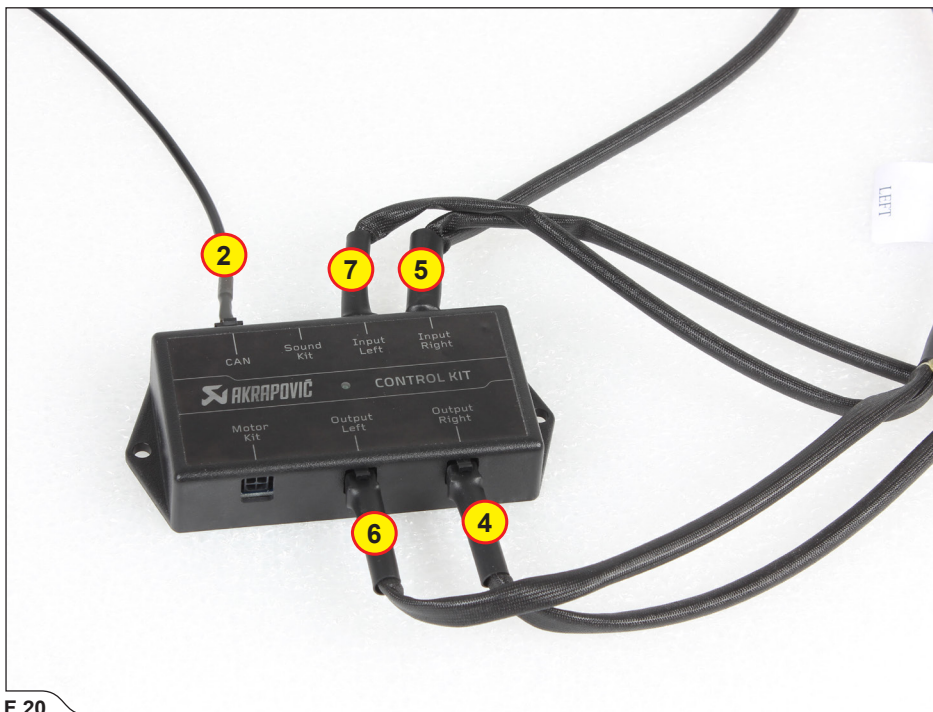

F 20

! IMPORTANT: 3pin to 4pin adapters are used for vehicles with stock 3pin connector (F 21).

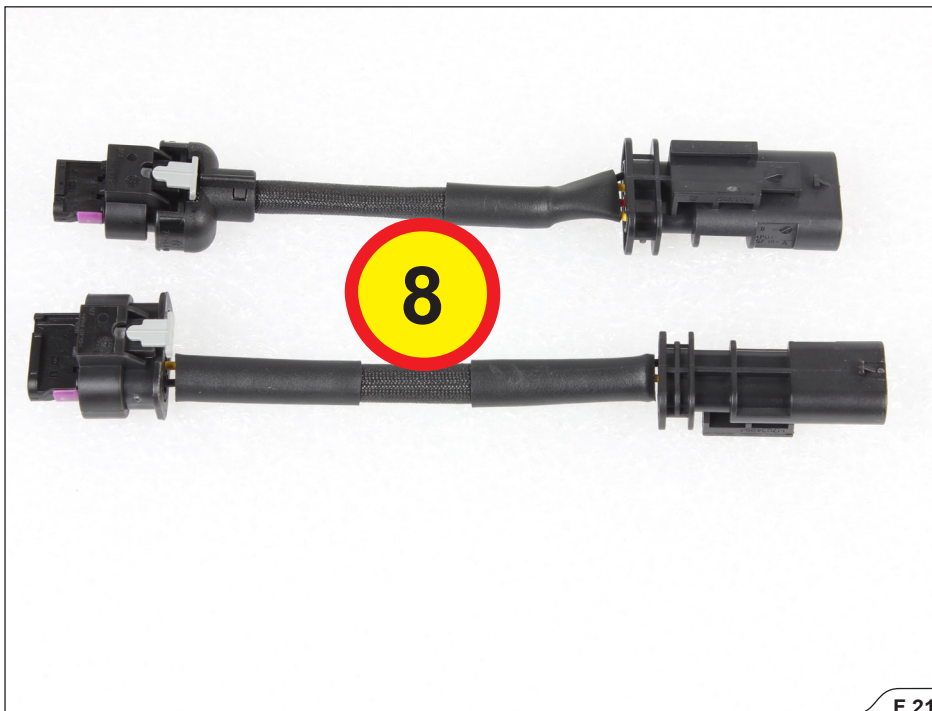

! **IMPORTANT:** connector plugs are used for vehicles WO stock exhaust flaps (F 22, 23).



F 22

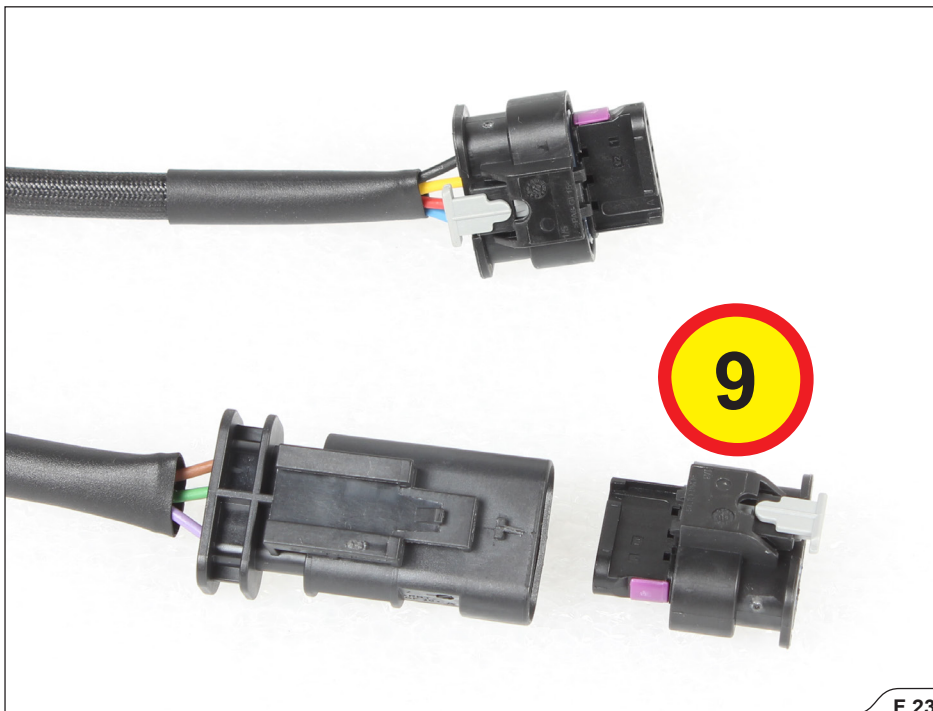

4. Carefully pull the Akrapovič exhaust flaps wiring harness through the opening in the trunk and correctly install the rubber grommet (**F 24, 25**).

! **CAUTION:** make sure not to injure yourself or damage any part of the vehicle during this process!

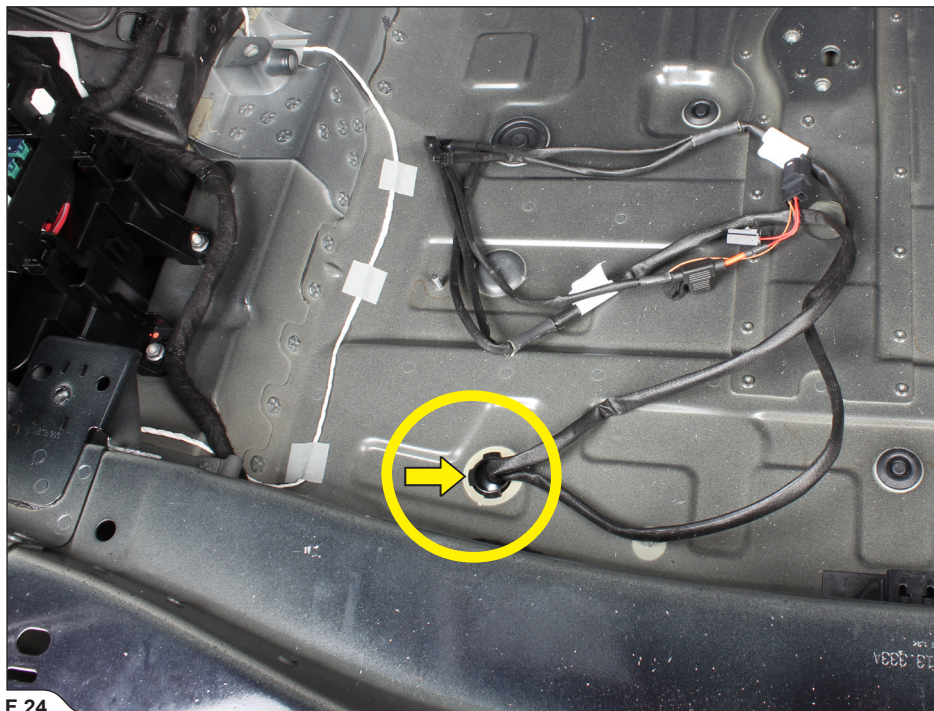

F 24

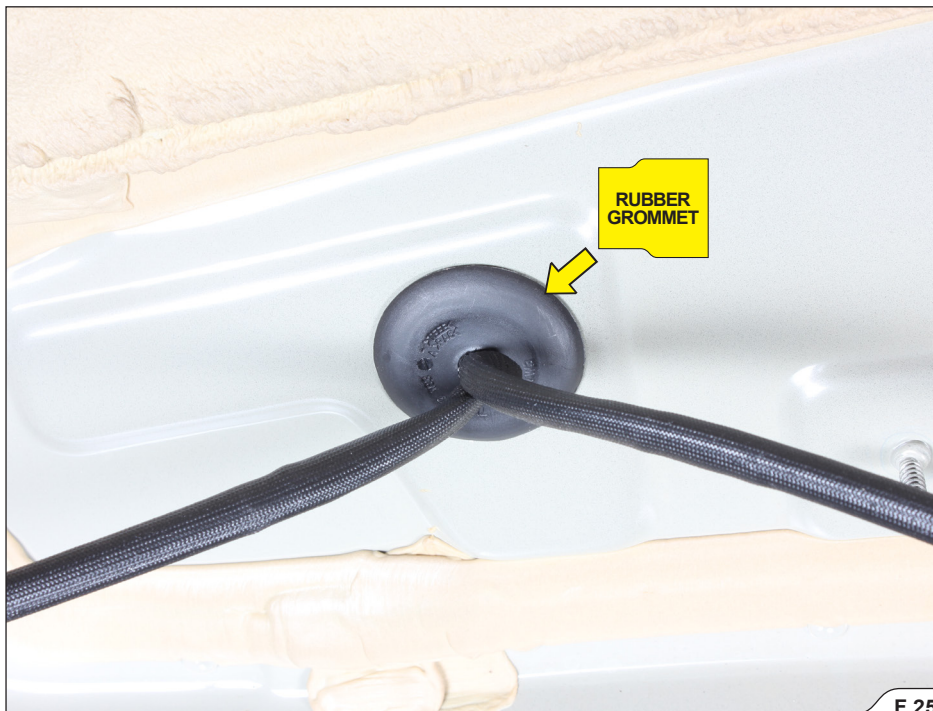

5. Lead the exhaust flaps' wiring harnesses to the left and right side of the vehicle, as shown (F 26).
! CAUTION: make sure not to injure yourself or damage any part of the vehicle during this process!

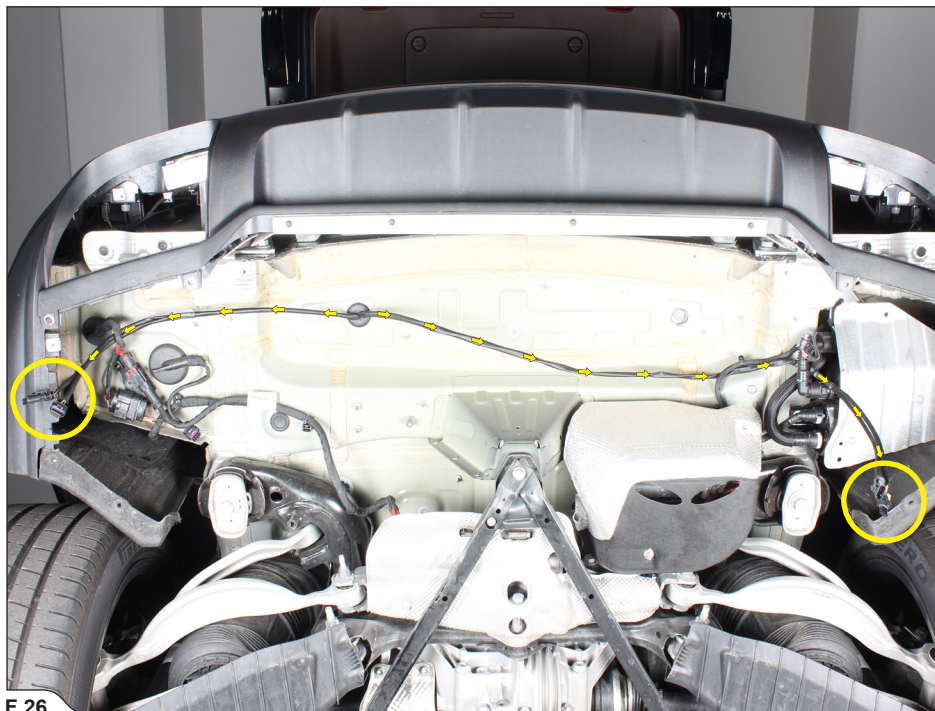

F 26

6. Reinstall the heat shield (F 27).

! **CAUTION:** make sure not to injure yourself or damage any part of the vehicle during this process!

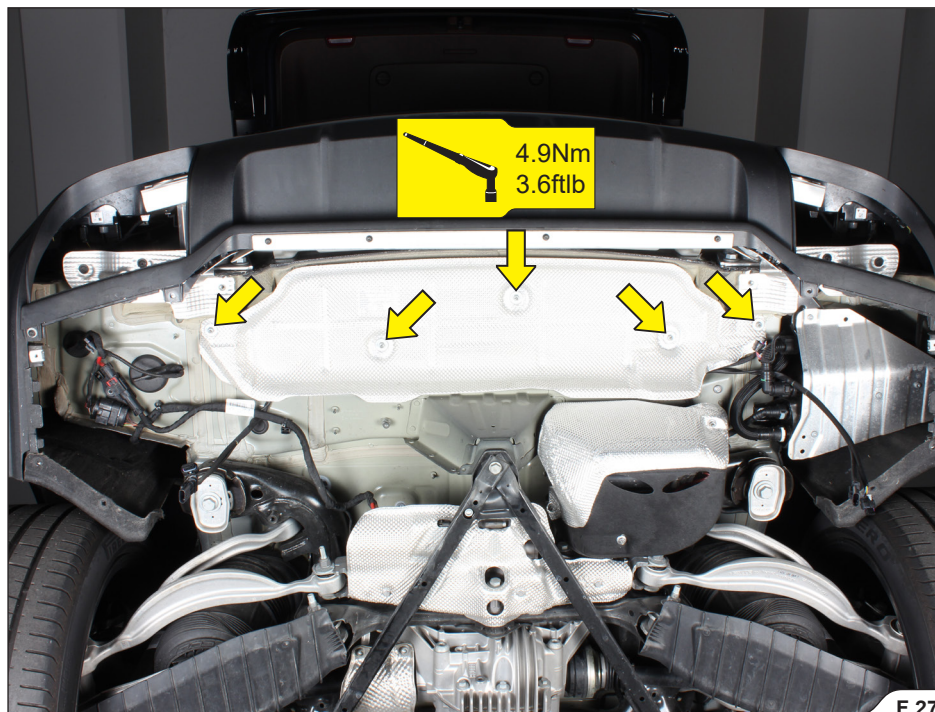

F 27

7. Install and connect the Sound kit components in the trunk, as shown; secure all wiring and components in place using tie wraps from Akrapovič installation kit (F 28, 29, 30, 31, 32).

! **IMPORTANT:** make sure to secure all Sound Kit components in such a way, that they won't touch any hot or moving parts of the vehicle!

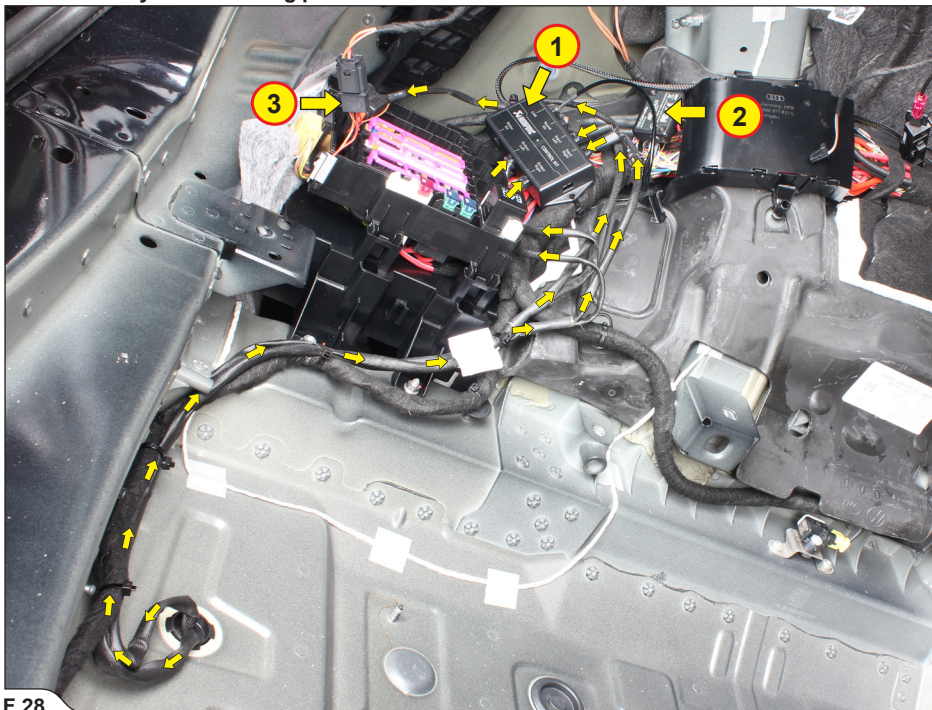

F 28

! **IMPORTANT:** connect the Sound kit's power supply connector to the vehicle's power socket connector, as shown (F 29).

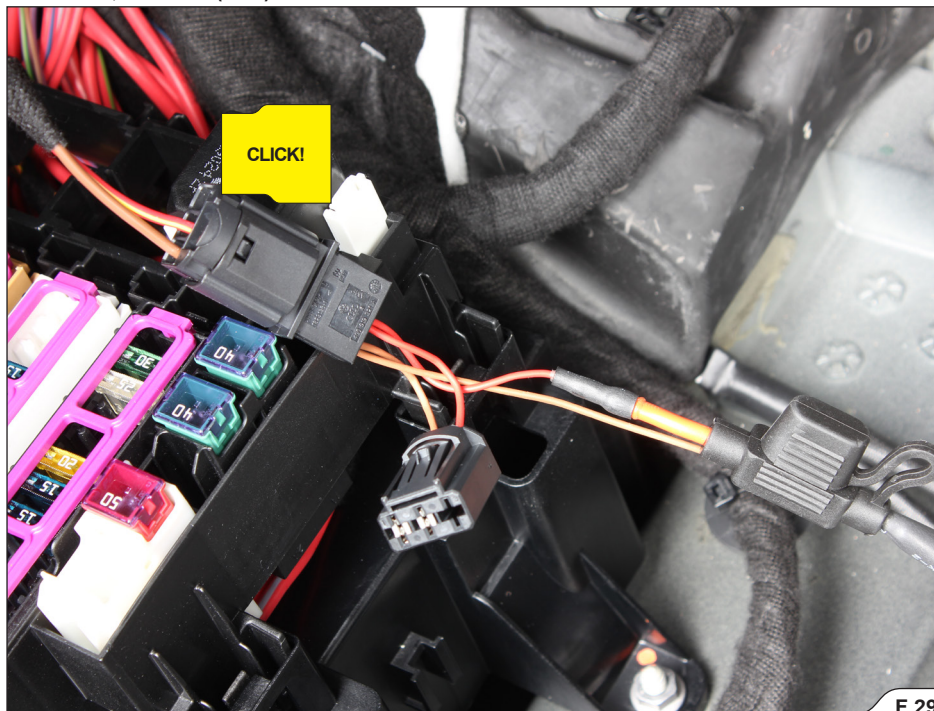

! IMPORTANT: unscrew the CAN sniffer's cover, lead the orange and green wires through the CAN sniffer's wire grooves as shown and reinstall the cover (F 30, 31).

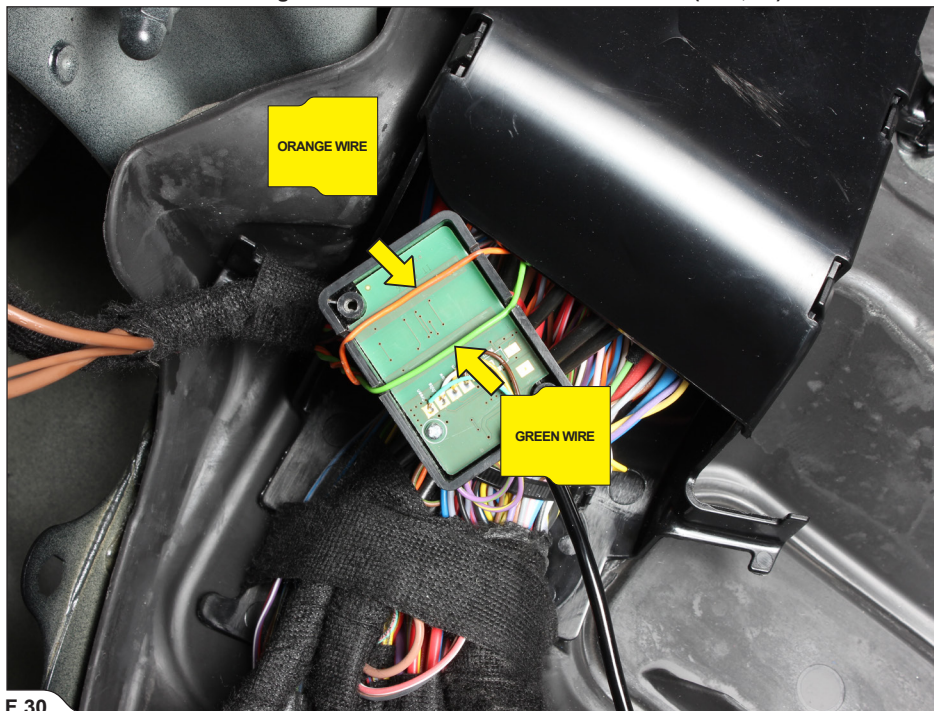

F 30

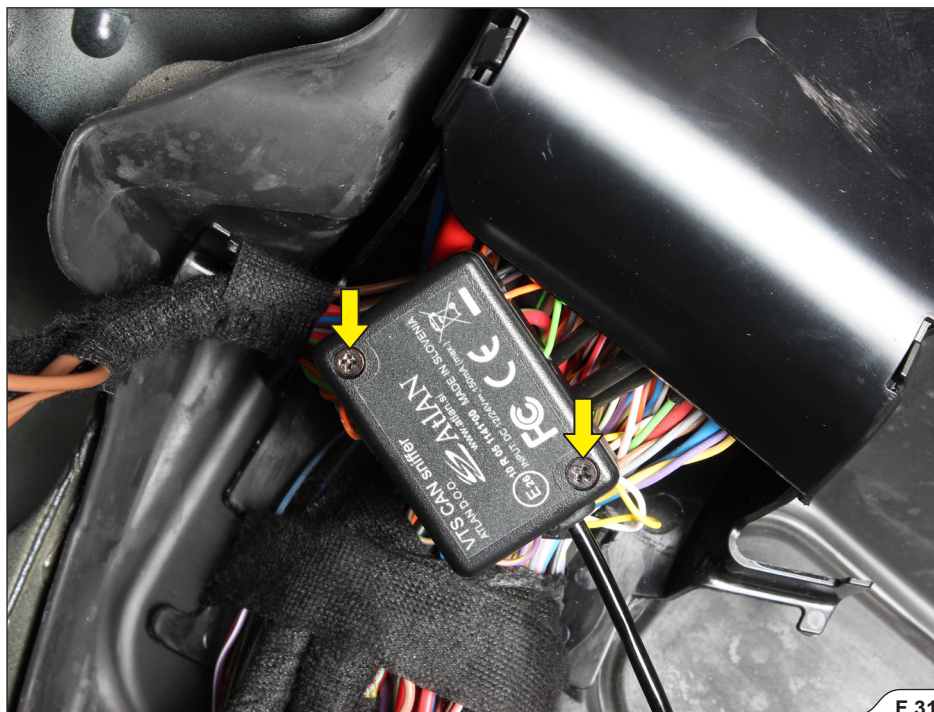

F 31

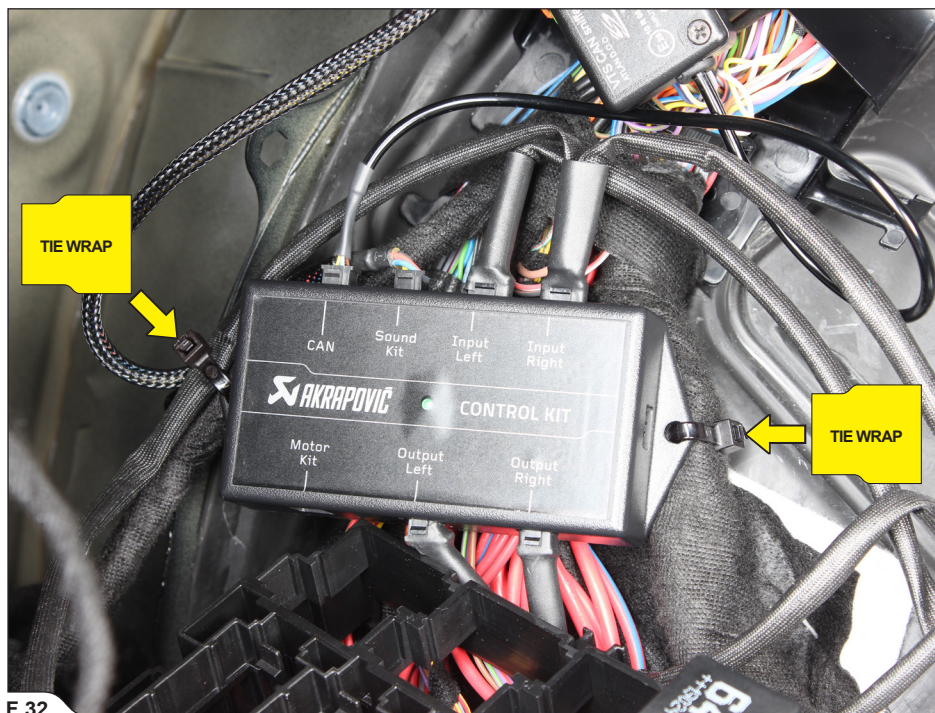

F 32

8. Mark the link pipes, 42 mm (1,65 in) from the beginnings, for later adjustments, as shown (F 33, 34, 35).



F 33



F 34

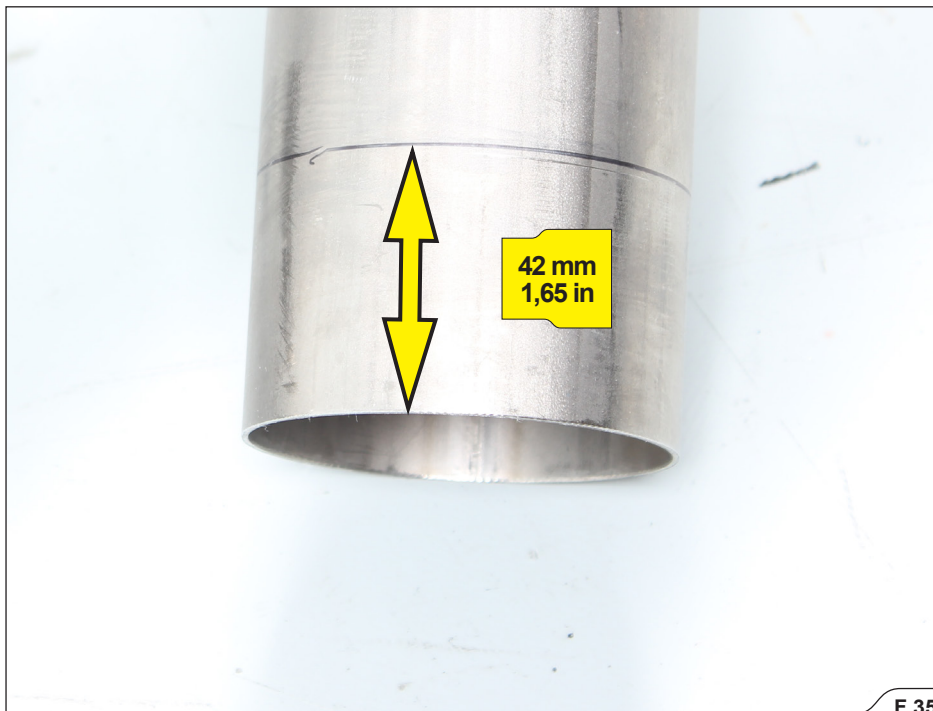

9. Assemble the muffler and link pipes, as shown, using clamps from Akrapovič installation kit and stock rubber brackets (F 36, 37, 38).

INSTALLATION TIP: for easier mounting, lubricate the original rubber brackets (WD40®)*.
*WD-40® is a trademark of the WD-40 Company.

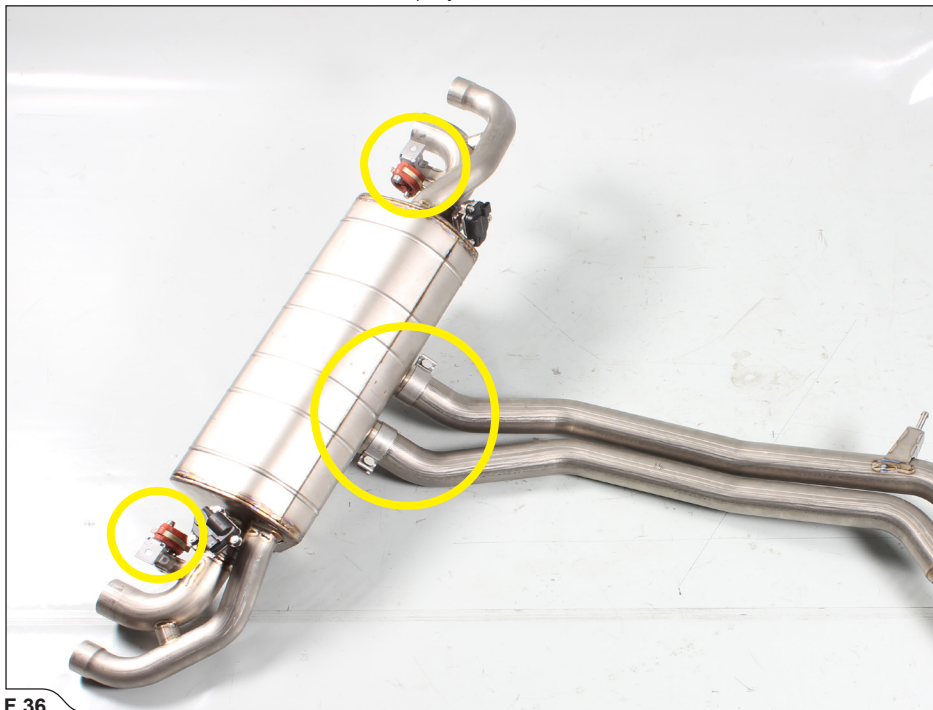

F 36

! IMPORTANT: hand tighten the clamps only (F 37)!

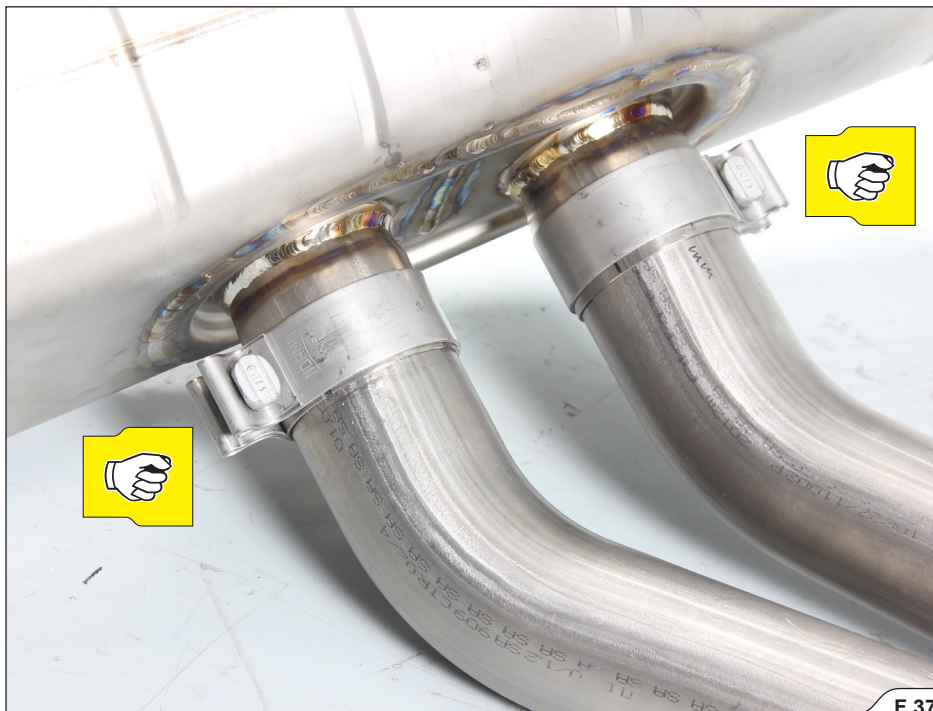

F 37

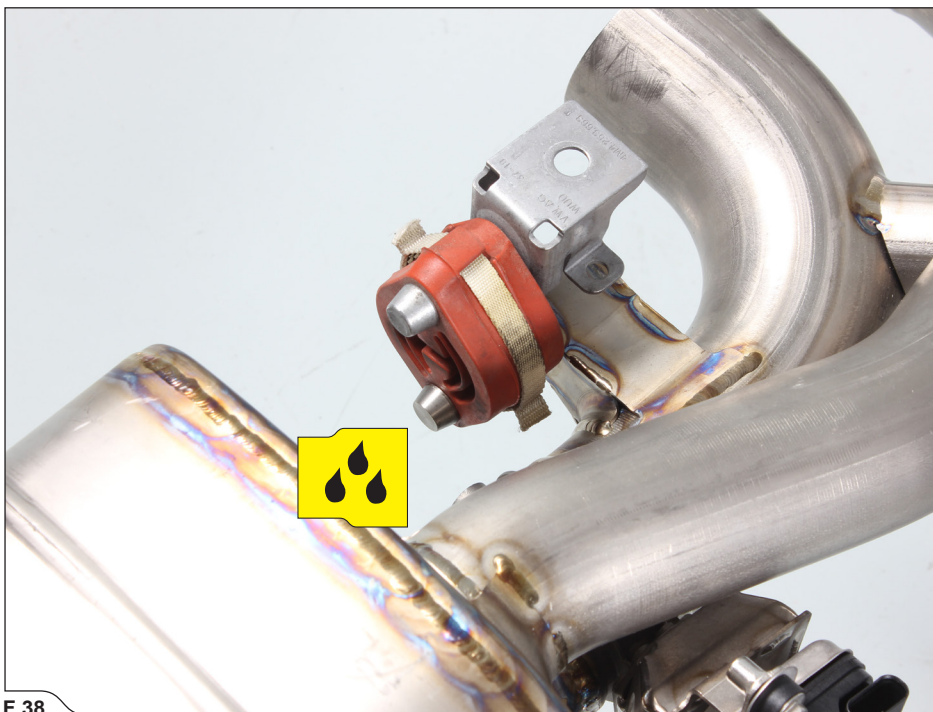

F 38

10. Carefully install the Akrapovič exhaust system onto the vehicle; tighten and attach all rubber brackets onto the chassis (F 39, 40, 41, 42).

! CAUTION: make sure not to injure yourself or damage the vehicle or exhaust system during this process!

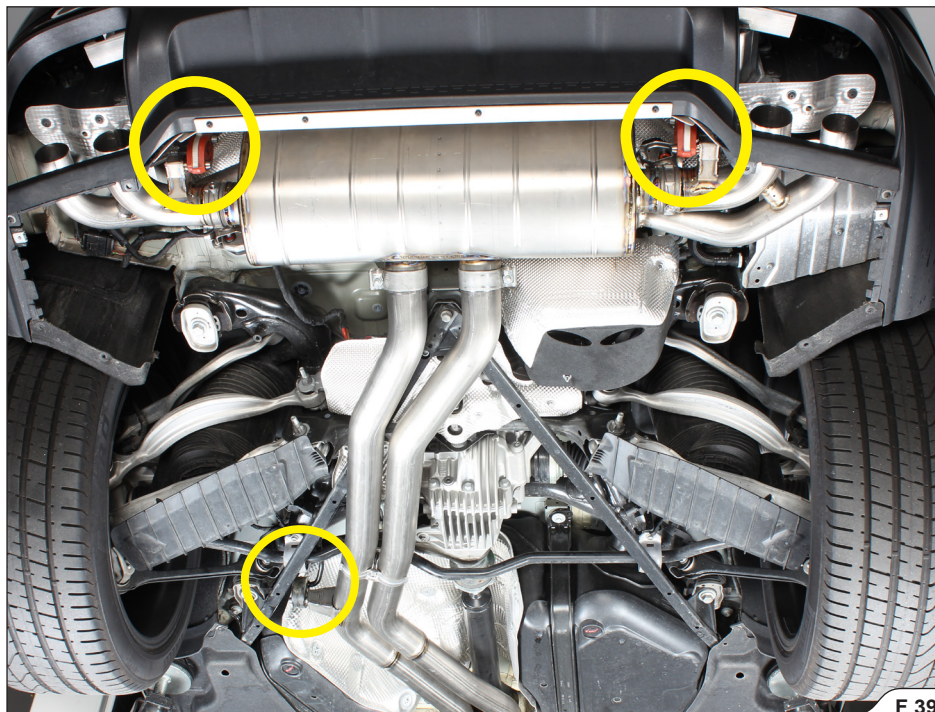

F 39

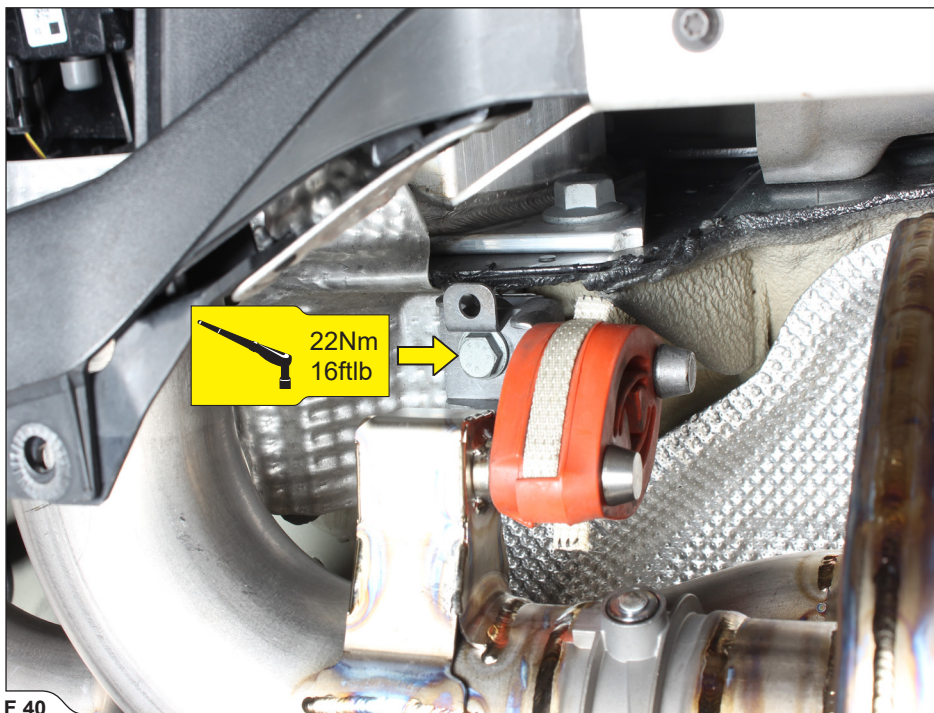

F 40

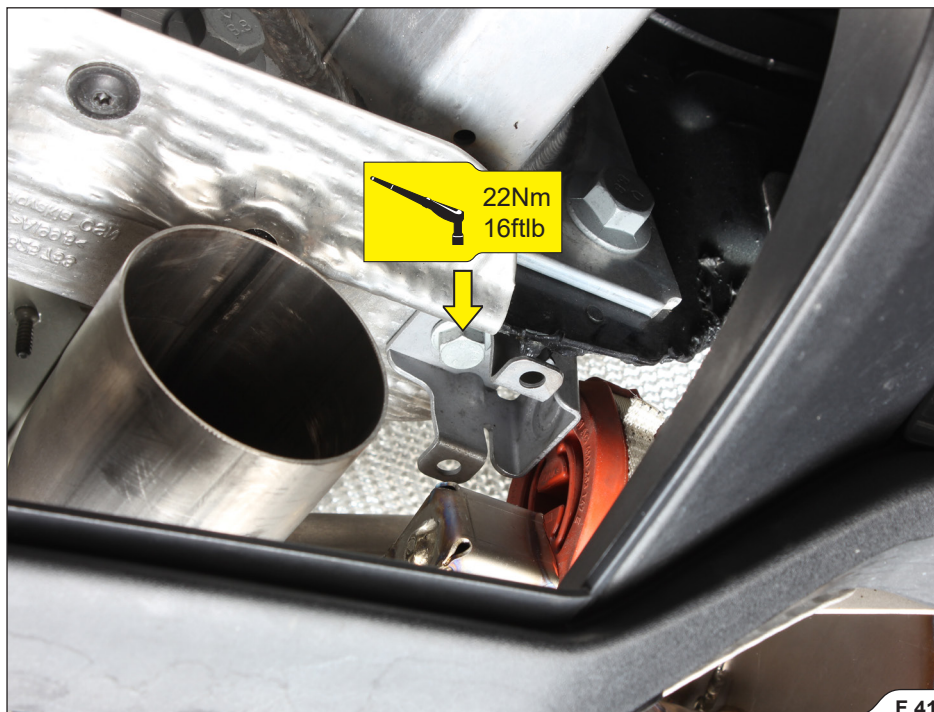

W **INSTALLATION TIP:** for easier mounting, lubricate the original rubber bracket (WD40®)*.
*WD-40® is a trademark of the WD-40 Company.

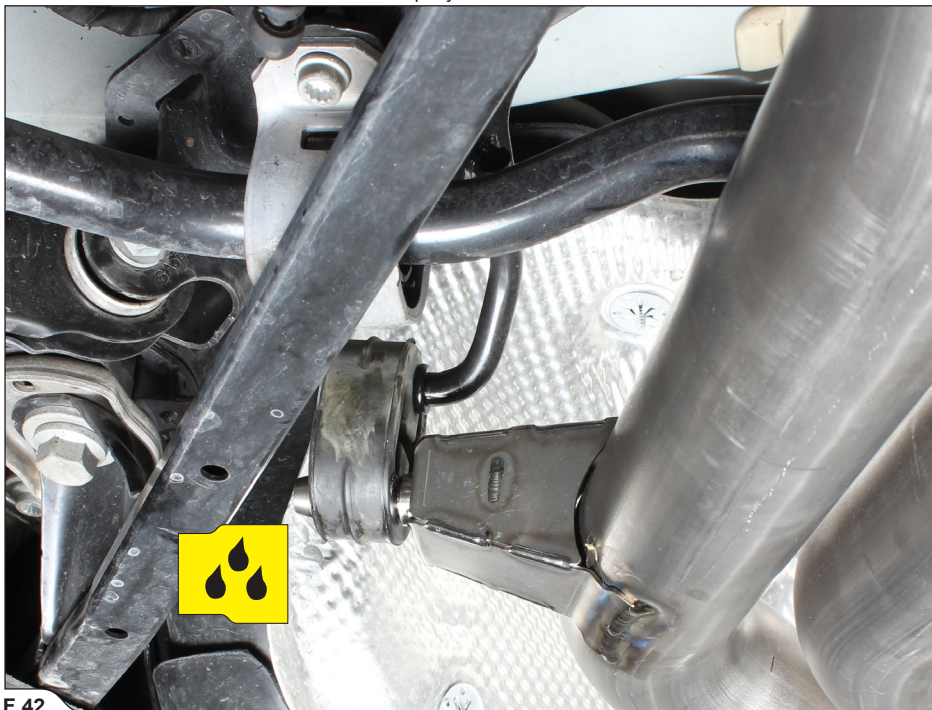

F 42

11. Push/wiggle the muffler onto the link pipes to the marks, adjust the clamps as shown and tighten the clamps to the specified torque (F 43).

! **CAUTION:** make sure not to injure yourself or damage the vehicle or exhaust system during this process!

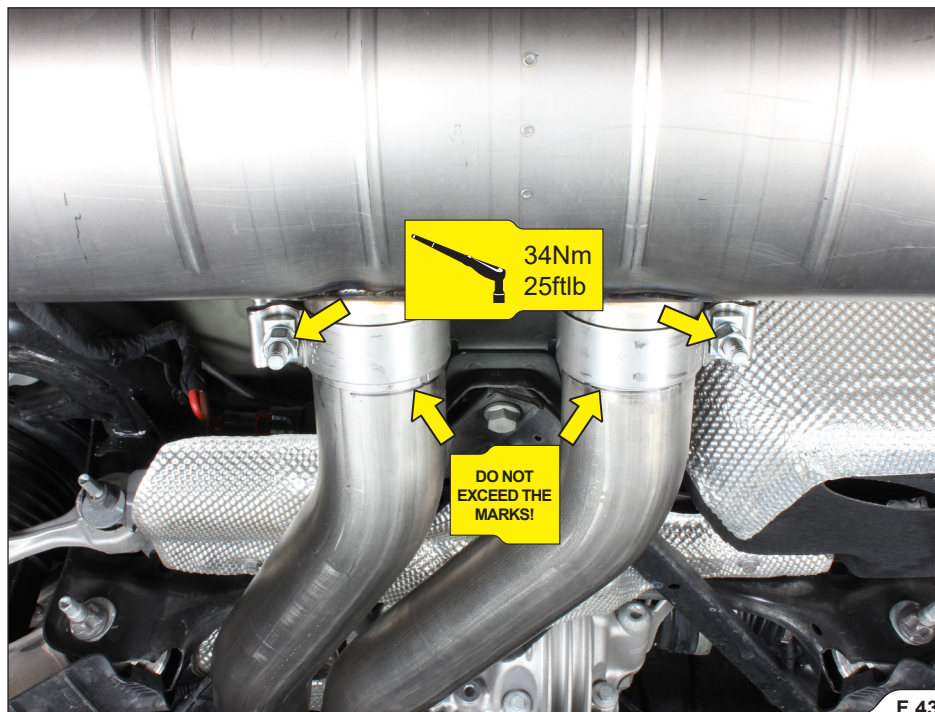

12. Align the muffler in respect to the chassis and adjust the muffler in such a way, that the clearance between muffler and vehicle's heat shield is minimum 12 mm (0,47 in); do not exceed the 42 mm (1,65 in) marks at the link pipes - stock pipe connection (F 44, 45).

! **CAUTION:** make sure not to injure yourself or damage the vehicle or exhaust system during this process!

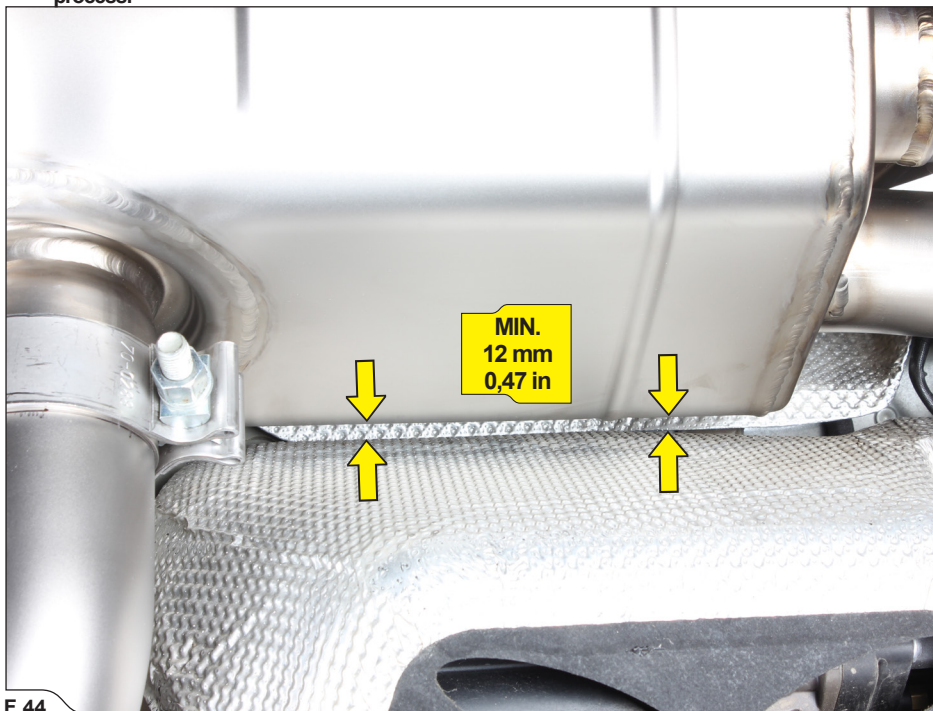

F 44

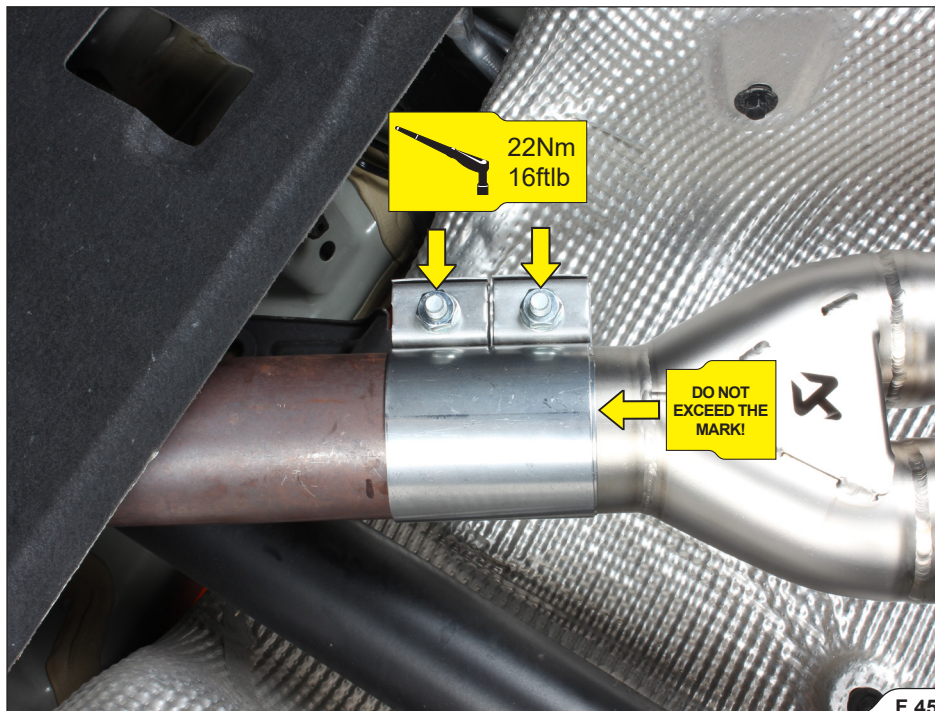

13. Install the pipe connection from Akrapovič installation kit, exactly as shown(F 46).

! **CAUTION:** make sure not to injure yourself or damage any part of the vehicle during this process!

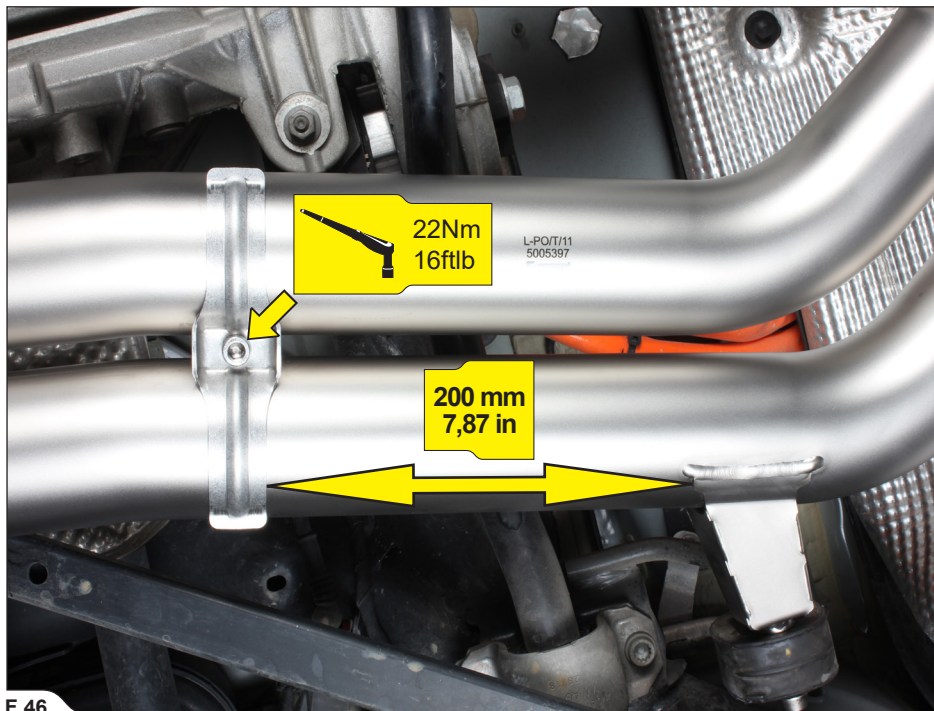

F 46

14. For vehicles WITH stock exhaust flap(s) only: connect the exhaust flap actuator(s), using 3pin to 4pin adapter(s) from Akrapovič installation kit (F 47).

! CAUTION: make sure not to injure yourself or damage any part of the vehicle during this process!

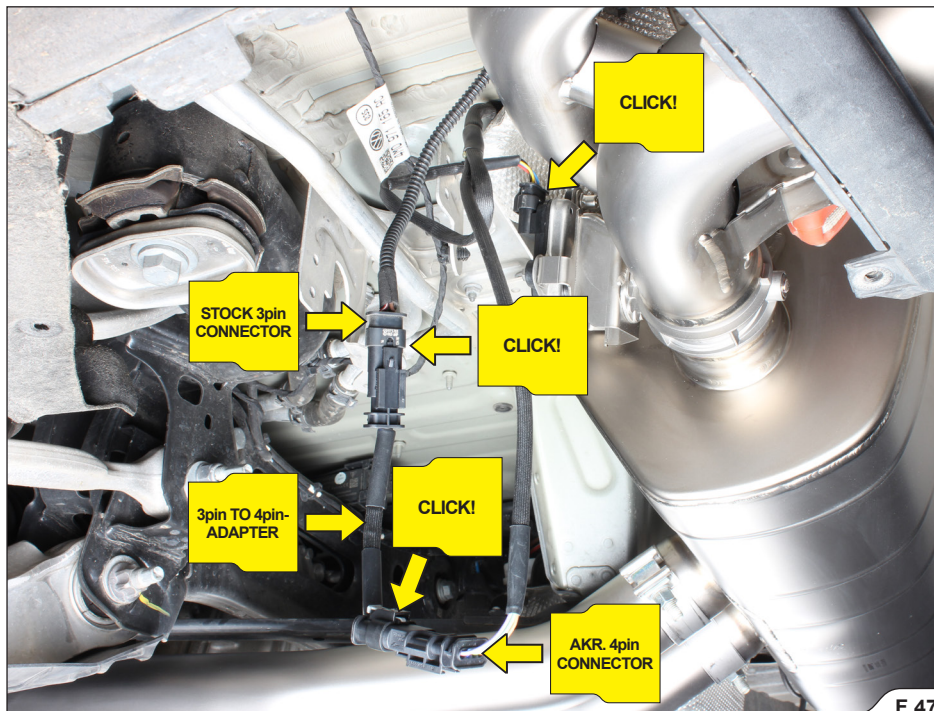

15. For vehicles **WO** stock exhaust flap(s) **only**: connect the exhaust flap actuators, and plug the free connectors, using plugs from Akrapovič installation kit (F 48).

! **CAUTION:** make sure not to injure yourself or damage any part of the vehicle during this process!

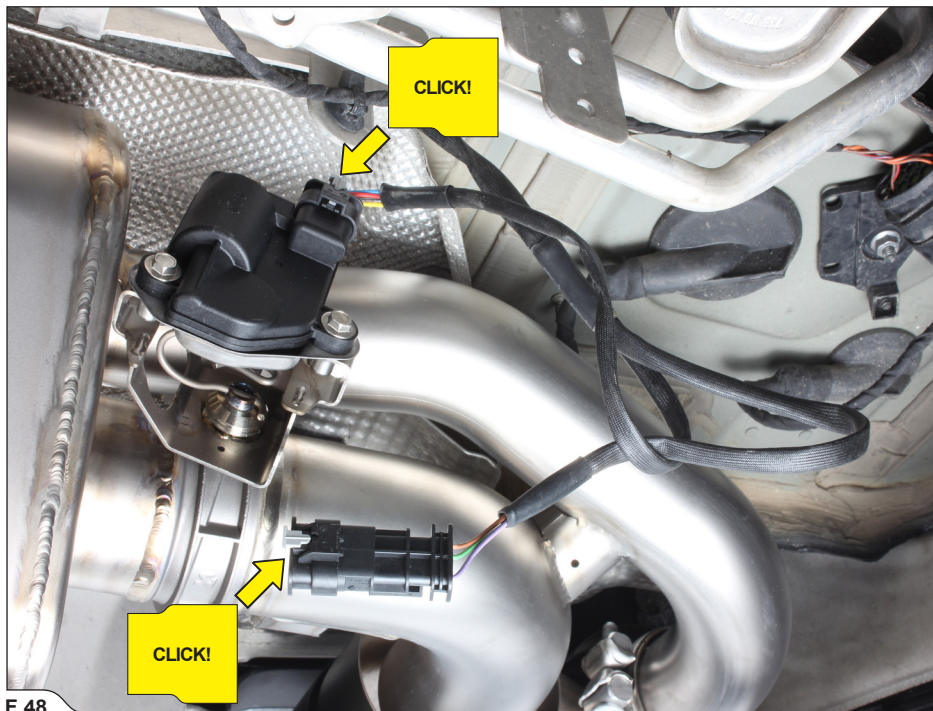

F 48

16. Secure the wiring and connectors, as shown, using tie wraps from Akrapovič installation kit (F 49, 50).

! **IMPORTANT:** make sure to secure the wiring harness in such a way, that it won't touch any hot or moving parts of the vehicle!

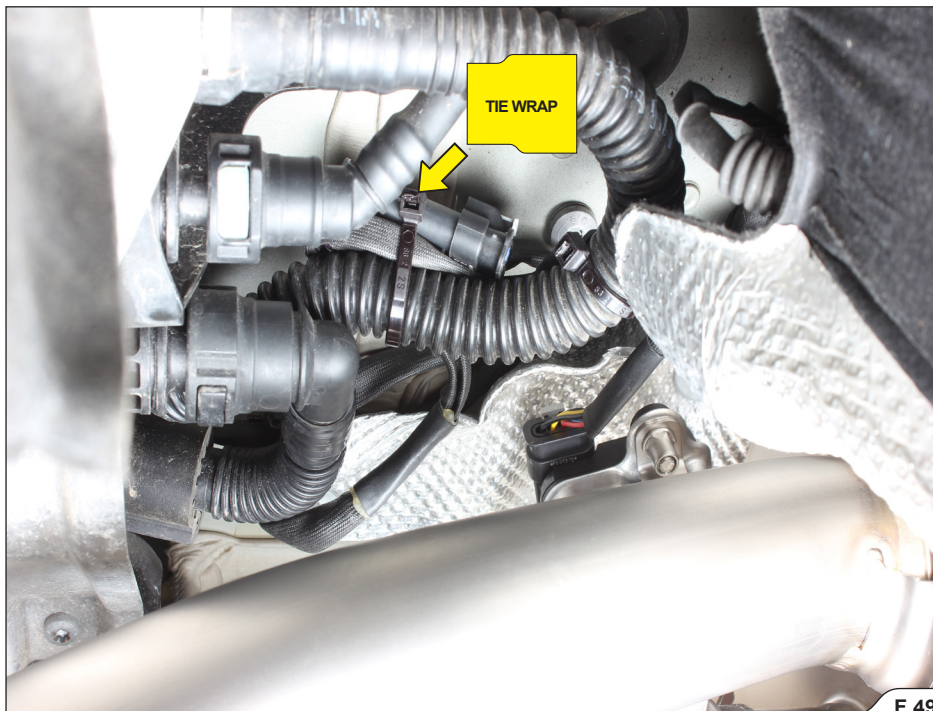

F 49

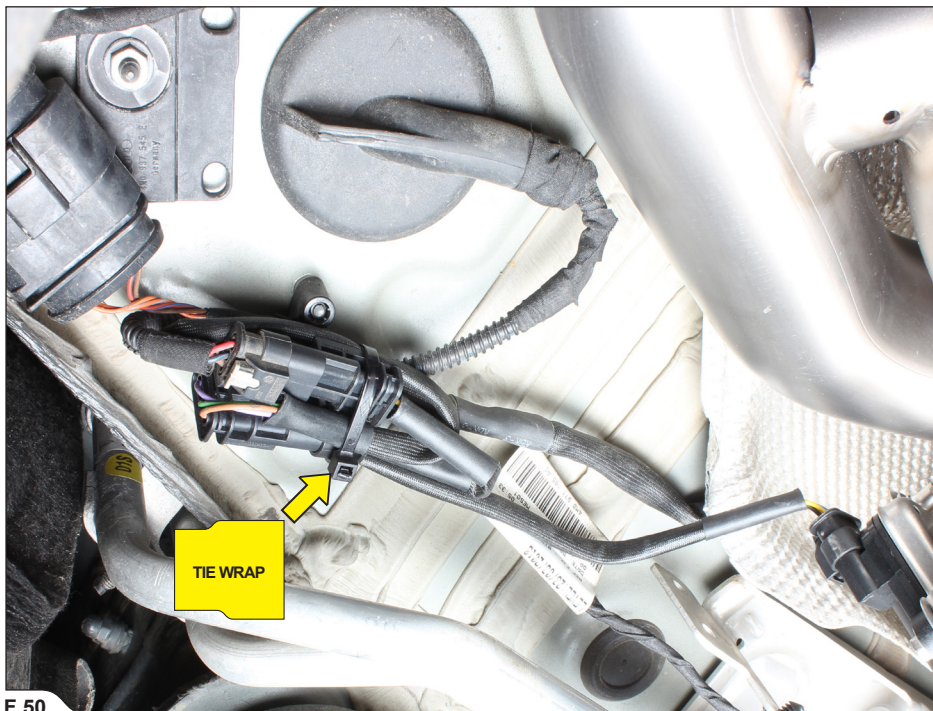

F 50

17. Assemble the tail pipes as shown and slide them onto the muffler outlets (F 51, 52, 53).

! **IMPORTANT:** make sure, not to damage tail pipes, bumper or any part of the vehicle during this process!



F 51



F 52



F 53

18. Rotate and center the tail pipes in respect to rear bumper and according to your personal preference and tighten the clamps to the specified torque (F 54, 55, 56).

! **IMPORTANT:** the minimum clearance between tail pipes and stock heat shield at any point is 8 mm (0,32 in)!



F 54



F 55

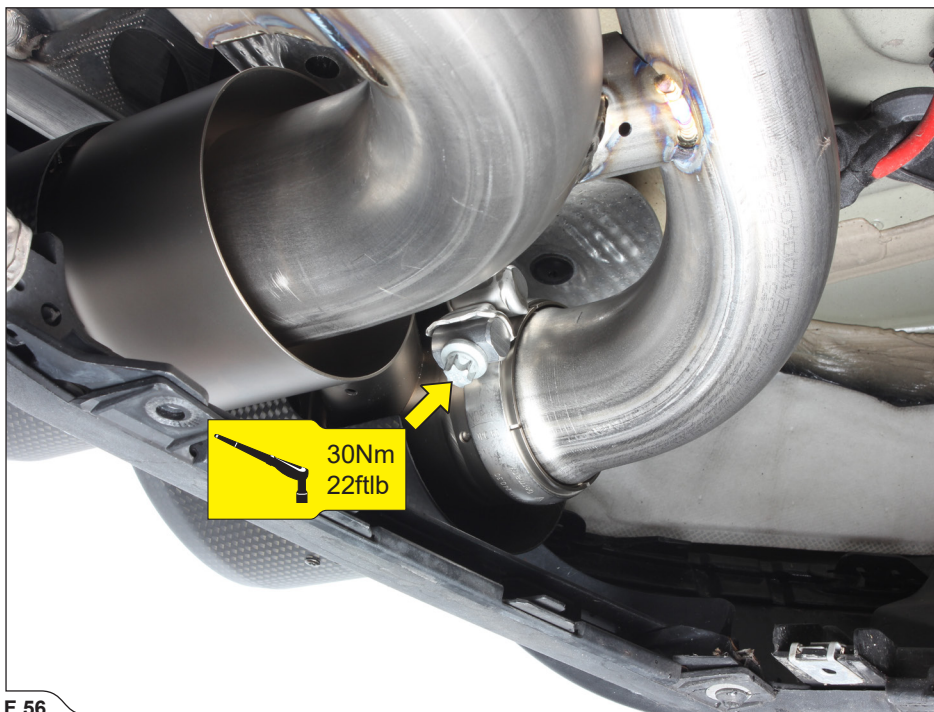

F 56

FINAL INSTALLATION:

- ! **IMPORTANT:** reinstall the dismantled or partially removed stock parts (wheel arches, bumper etc.); check vehicle manufacturer manual for tightening torques.
- ! **IMPORTANT:** make sure all the nuts and bolts are sufficiently tightened. In case the exhaust system touches the cowling or other parts, repeat the adjustment of the exhaust system or contact your authorized dealer.
- ! **IMPORTANT:** clean all exhaust components before the first start of the engine or the stains will burn onto the surfaces!

MAINTENANCE OF THE AKRAPOVIČ EXHAUST SYSTEM:

1. Clean the titanium exhaust components with a multi-purpose spray lubricant (WD-40[®] or equivalent)*, carbon fiber exhaust components with soft and dry cloth and stainless steel components with soft cloth sprayed with contact cleaner, then wipe with soft and dry cloth. A change in the color of the exhaust system is normal due to high temperatures.
2. Periodically make sure all the bolts and springs are sufficiently tight.

*WD-40[®] is a trademark of the WD-40 Company.

 **INSTALLATION TIP: IT IS NORMAL FOR WHITE SMOKE TO COME OUT OF THE MUFFLER AT FIRST OPERATION.**

- ! **CAUTION: DO NOT STAND BEHIND THE MUFFLER AT ANY TIME.**
- ! **CAUTION: DO NOT USE AUTOMOTIVE WHEEL CLEANERS OR ANY CLEANING PRODUCTS WHICH CONTAIN ACIDIC ADDITIVES TO CLEAN THE AKRAPOVIČ EXHAUST SYSTEMS.**

WARNING: THE EXHAUST SYSTEM CAN BE EXTREMELY HOT. ALLOW THE EXHAUST AND ENGINE TO COOL DOWN BEFORE BEGINNING INSTALLATION OR ANY OTHER WORK ON THE EXHAUST SYSTEM. THIS MANUAL IS SPECIFIC TO THE PORSCHE CAYENNE TYPE 536 NON OPF/GPF. THERE MAY BE SOME DIFFERENCES IN INSTALLATION PROCEDURES FOR OTHER MODELS.

TROUBLESHOOTING:

Problem	Possible cause	
Exhaust gas leaks out of the muffler/pipe clamp connections	loosened clamp	<p>Solution tighten the clamp to specified torque</p>
	connection is not completely joined	tap the connection into place and tighten the clamp to specified torque
Valves are not moving	No supply	<p>Check green LED on the Control Kit. If the LED is off:</p> <ul style="list-style-type: none"> • Check electrical connection and connectors • Check fuse for exhaust valves
	Error detected	<p>Check green LED on the Control Kit. If the LED blinks one time per period:</p> <ul style="list-style-type: none"> • Check left input harness and connectors. <p>If the LED blinks two times per period:</p> <ul style="list-style-type: none"> • Check Right Input harness and connectors. <p>If the LED is continuously blinking:</p> <ul style="list-style-type: none"> • Check if CAN sniffer is properly installed. • Check CAN sniffers connections and connector <p>Period lasts approximately one second.</p>

DECLARATION OF CONFORMITY OF CONTROL KIT

COMPANY: Akrapovič d.d.
ADDRESS: Malo Hudo 8a
1295 Ivančna Gorica, Slovenia

declares that the following products:

Product name: Control Kit
Trade Name: Akrapovič
Type or model: P-HF886

is in conformity with the requirements of the following Directives of the European Union:
Regulation UN/ECE-R10 rev5



10 R - 05 1139

FCC NOTICE

This device complies with part 15 of the FCC rules. Operation is subject to the following two conditions: **(1)** This device may not cause harmful interference, and **(2)** this device must accept any interference received, including interference that may cause undesired operation.

Changes or modifications not expressly approved by the party responsible for compliance could void the user's authority to operate the equipment.

You can view your product's FCC Declaration of Conformity (DoC) to the FCC 47 CFR Part 15, SubpartB, at <http://www.akrapovic.com/docs/ControlKit/FCCCertification.pdf>.

Industry Canada compliance statement

This Class B digital apparatus complies with Canadian ICES-003. This device complies with Industry Canada licence-exempt RSS standard(s). Operation is subject to the following two conditions:

(1) this device may not cause interference, and **(2)** this device must accept any interference, including interference that may cause undesired operation of the device.

Cet appareil numérique de la classe B est conforme à la norme NMB-003 du Canada. Le présent appareil est conforme aux CNR d'Industrie Canada applicables aux appareils radio exempts de licence. L'exploitation est autorisée aux deux conditions suivantes :

(1) l'appareil ne doit pas produire de brouillage, et **(2)** l'utilisateur de l'appareil doit accepter tout brouillage radioélectrique subi, même si le brouillage est susceptible d'en compromettre le fonctionnement.

European Union Directives Conformance Statement

CE Akrapovič d.d. hereby declares that this Akrapovič Control Kit P-HF886 is in compliance with the essential requirements and other relevant provisions of Directive 2004/108/EU

You can view your product's Declaration of Conformity (DoC) to Directive 2004/108/EU (to EMC Directive) at <http://www.akrapovic.com/docs/ControlKit/CECertification.pdf>.

DECLARATION OF CONFORMITY

COMPANY: Atlan d.o.o.
ADDRESS: Sveti Anton, Hrib 9
6276 Pobegi, Slovenia

declares that the following products:

Product name: Communication Detector
Trade Name: Atlan
Type or model: VTS CAN SNIFFER

is in conformity with the requirements of the following Directives of the European Union:
Regulation UN/ECE-R10 rev5



10 R - 05 1141

FCC NOTICE

This device complies with part 15 of the FCC rules. Operation is subject to the following two conditions: **(1)** This device may not cause harmful interference, and **(2)** this device must accept any interference received, including interference that may cause undesired operation.

Changes or modifications not expressly approved by the party responsible for compliance could void the user's authority to operate the equipment.

You can view your product's FCC Declaration of Conformity (DoC) to the FCC 47 CFR Part 15, SubpartB, at <http://www.akrapovic.com/docs/CanSniffer/FCCCertification.pdf>.

Industry Canada compliance statement

This Class B digital apparatus complies with Canadian ICES-003. This device complies with Industry Canada licence-exempt RSS standard(s). Operation is subject to the following two conditions:

(1) this device may not cause interference, and **(2)** this device must accept any interference, including interference that may cause undesired operation of the device.

Cet appareil numérique de la classe B est conforme à la norme NMB-003 du Canada. Le présent appareil est conforme aux CNR d'Industrie Canada applicables aux appareils radio exempts de licence. L'exploitation est autorisée aux deux conditions suivantes :

(1) l'appareil ne doit pas produire de brouillage, et **(2)** l'utilisateur de l'appareil doit accepter tout brouillage radioélectrique subi, même si le brouillage est susceptible d'en compromettre le fonctionnement.

European Union Directives Conformance Statement

CE Atlán d.o.o. hereby declares that this Atlán Communication Detector VTS CAN SNIFFER is in compliance with the essential requirements and other relevant provisions of Directive 2004/108/EU

You can view your product's Declaration of Conformity (DoC) to Directive 2004/108/EU (to EMC Directive) at <http://www.akrapovic.com/docs/CanSniffer/CECertification.pdf>.

[EMPTY PAGE]

[EMPTY PAGE]

www.akrapovic.com



507136