



Installation instructions

Akrapovič Exhaust System:
Evolution
for the
Porsche 911 GT3 (type 991)



Installation instructions

Akrapovič Exhaust System:
Evolution
for the
Porsche 911 GT3 (type 991)

Congratulations on purchasing an Akrapovič exhaust system. Please read the entire installation manual prior to undertaking any activities related to installation of your new Akrapovič exhaust system. In case you do not fully understand the manual or any of its parts, please contact your authorized dealer!

This product should be installed by someone with sufficient knowledge of exhaust systems and their installation, and appropriate hand or power tools. If you are not qualified for this work, please utilize a certified mechanic for installation. By installing Your Akrapovič exhaust system, you indicate that you have read the installation manual in its entirety and you agree with the terms stated herein.

It is your responsibility to follow all installation instruction guidelines supplied with the Akrapovič exhaust system and undertake all necessary safety precautions. Akrapovič d.d. assumes no responsibility for damages occurring from misuse, abuse, improper installation, improper operation, lack of responsible care, or all previously stated reasons resulting from incompatibility with other manufacturer's products and/or systems.

IMPORTANT INFORMATION

Exclusion of Certain Liability

1. The manufacturer, importer or dealer shall not be liable for any incidental damage including personal injury or any other damages caused by improper installation or operation of the Akrapovič exhaust system. When installing the Akrapovič exhaust system be careful that the exhaust system does not touch other parts sensitive to high temperature.
2. Akrapovič makes no representation or warranties with regard to damage caused by the improper installation, use and maintenance of the Akrapovič exhaust system. The warranty is limited to defects recognized by our technical department and due to normal use, and excludes items subject to normal wear (gaskets and damping wool). The guarantee is void in case of accident, modification, improper or competition use.
3. Do not attempt to install the Akrapovič exhaust system on a vehicle model for which it was not made or tested by Akrapovič.
4. When the exhaust system gets very hot during operation, be careful not to burn yourself on the exhaust system or parts which are in direct contact with it, even when the engine is not running. Also protect other people, especially children, from the injuries mentioned above.

1. In some cases Akrapovič exhaust system kits contain chemical products (ceramic anti-seizing grease; bolt sealant). Handle with care, do not inhale or swallow. Avoid excessive contact with skin, eyes or mucous membranes. Keep out of reach of children.
2. Technical specifications of Akrapovič exhaust systems and related products are subject to change without notice.
3. Before removing the original exhaust system from your vehicle, please compare the parts you received with the list of materials provided in the installation manual in order to assure that you have all the parts necessary for the installation of your new Akrapovič exhaust system.
4. Although this manual consists of instructions for installation in written form, as well as photographs and pictures representing individual steps of the installation, please note that the photographs and pictures are symbolic and are intended for representation of general overview only. The photographs and pictures contained herein should serve as a guideline only and actual installation of the exhaust system may not correspond with the photographs and pictures entirely.
5. The process of uninstalling the original exhaust system may vary depending on the existing exhaust system. Please follow the original exhaust system manufacturer's instructions for uninstalling the original exhaust system.

Trademarks

The Akrapovič trademark, including corporate logos and emblems, are subject to copyright as well as trademark rights of Akrapovič, its licensors or third persons authorizing Akrapovič to use them.

Akrapovič website

Information about Akrapovič exhaust systems and related products is available on the Akrapovič website at:

<http://www.akrapovic.com/>

Copyright

No part of the Akrapovič exhaust system or its documentation may be reproduced or distributed in any form or by any means without the prior written authorization of the Akrapovič company.

© Akrapovič, d.d. All rights reserved.

Symbols

The following symbols are used throughout these installation instructions:



TOOLS REQUIRED



TIGHTENING TORQUE



INSTALLATION TIP



CAUTION OR WARNING



USE BOLT SEALANT; Apply 3 to 4 small drops of bolt sealant onto the cleaned and degreased threads before tightening the bolts. **WARNING! Avoid contact with skin, eyes and mucous membranes. Do not inhale fumes. Keep out of the reach of children.**



USE ANTI-SEIZE LEAD-FREE COPPER PASTE (black tube); Provides trouble-free and long-lasting protection against seizing, corrosion and rusting of bolts, threaded ends, nuts, joints, etc. Also protects against vibration, wear and impact. **WARNING! Avoid eye contact. Avoid excessive skin contact. Keep out of reach of children.**



USE ANTI-SEIZING GREASE (white tube); Prevents seizing, corrosion and excessive wear between the titanium components of your exhaust system. **WARNING! Avoid eye contact. Avoid excessive skin contact. Keep out of reach of children.**



Screwdriver
T-handle swivelling 10 mm wrench
T-handle swivelling 13 mm wrench
T-handle 6 mm three hexagon wrench
Combination 22mm wrench
Torx 10
Torx 25
Torx 30
Cutting nippers
Clamp pliers



BEFORE INSTALLING, CHECK SCHEMATIC OF THE EXHAUST SYSTEM! THE LATEST VERSION OF THE PARTS LIST AND SCHEMATIC DRAWINGS OF THE PRODUCTS ARE AVAILABLE ON OUR WEB PAGE.



IF ANY ITEMS IN THE AKRAPOVIČ EXHAUST SYSTEM PACKAGE ARE MISSING, PLEASE CONTACT YOUR AUTHORIZED DEALER. KEEP THE SCHEMATIC FOR FUTURE REFERENCE.



THESE INSTALLATION INSTRUCTIONS MUST BE READ CAREFULLY IN ORDER TO ENSURE PROPER INSTALLATION AND OPERATION OF THE AKRAPOVIČ EXHAUST SYSTEM.



THE EXHAUST SYSTEM CAN BE EXTREMELY HOT. ALLOW THE EXHAUST AND ENGINE TO COOL DOWN BEFORE BEGINNING INSTALLATION.



WE ADVISE YOU TO LEAVE INSTALLATION TO A QUALIFIED SERVICEMAN. IMPROPER INSTALLATION MAY RESULT IN A SHORTER LIFETIME OF THE EXHAUST SYSTEM AND/OR DAMAGE TO THE VEHICLE.



WHEN INSTALLING AKRAPOVIČ'S AFTERMARKET OPTIONAL DOWN PIPES WITHOUT CATALYTIC CONVERTERS, WHICH ARE DEVELOPED FOR USE ON CLOSED TRACKS ONLY, REMAPPING OF THE ECU IS MANDATORY. THE AKRAPOVIČ COMPANY TAKES NO RESPONSIBILITY FOR ECU REMAPPING OR ANY POTENTIAL ISSUES RELATED TO THE USE OF AKRAPOVIČ DOWN PIPES.



AT EACH ENGINE START, THE EXUP VALVE MAY VIBRATE FOR A FEW SECONDS UNTIL THE VACUUM SYSTEM REACHES OPERATING PRESSURE.

REMOVAL OF STOCK EXHAUST:

Put the vehicle onto a car lift.

! **WARNING:** ensure that the car is lifted safely and properly in order to avoid the risk of vehicle damage, injury, or even death!

1. Unscrew the marked bolts, remove marked plastic pins and remove rear underbody panel (Figure 1).

! **CAUTION:** make sure not to injure yourself or damage any part of the vehicle during this process!

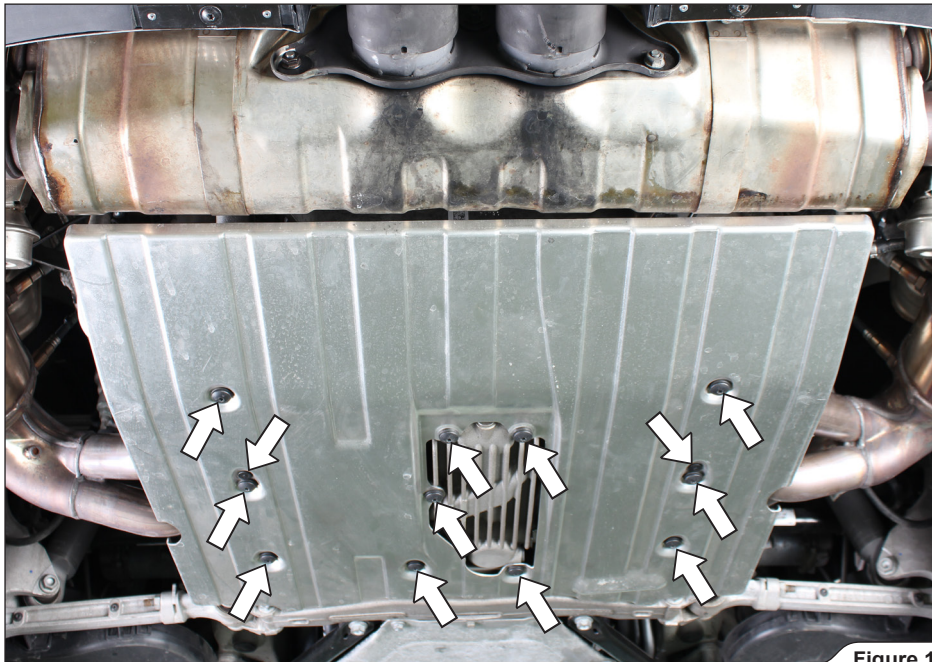

Figure 1

2. Unscrew the marked bumper bolts on both sides of the vehicle (**Figure 2**).
! CAUTION: be careful not to damage the vehicle during this process!



Figure 2

3. Unscrew the marked bolts (Figure 3).

! **CAUTION:** make sure not to injure yourself or damage any part of the vehicle during this process!



Figure 3

- Carefully pull the tail lights out of the chassis, disconnect the tail lights' electrical connectors and remove the tail lights off the vehicle, on both sides of the vehicle (**Figure 4**).

! **CAUTION:** make sure, not to damage the connectors, tail lights or any other part of the vehicle during this process!



Figure 4

5. Unscrew the marked bolts, on both sides of the vehicle (**Figure 5**).

! **CAUTION:** make sure not to injure yourself or damage any part of the vehicle during this process!



Figure 5

6. Disconnect the bumpers' electrical connector, and carefully remove the bumper off the vehicle (Figure 6).

! **CAUTION:** make sure, not to damage the connector, bumper or any other part of the vehicle during this process!

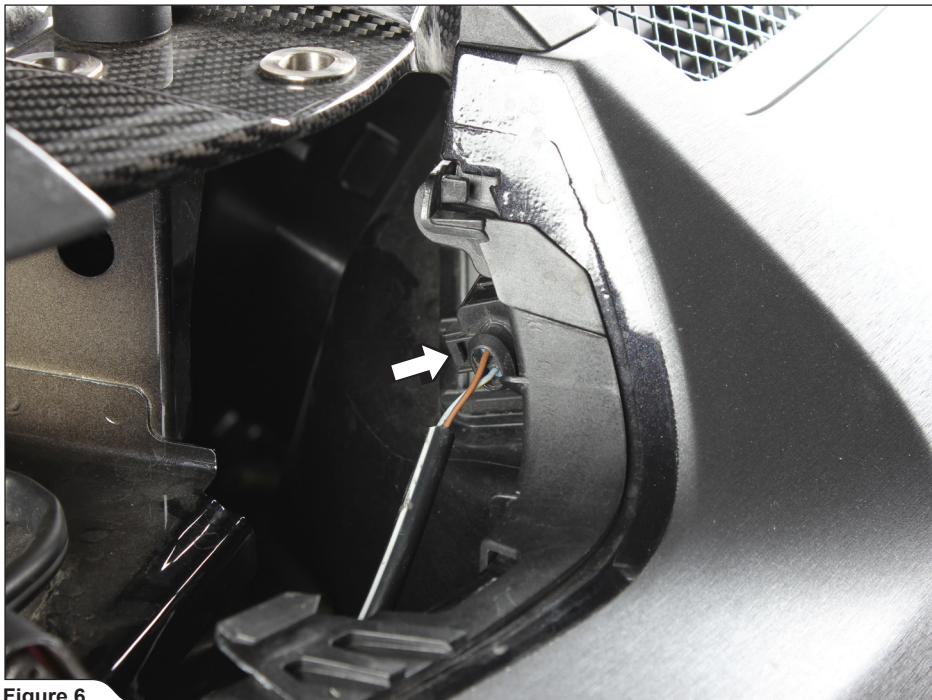

Figure 6

7. Unscrew the marked bolts, on both sides of the vehicle and remove exhaust heat shields (Figure 7, 8).
! CAUTION: make sure not to injure yourself or damage any part of the vehicle during this process!

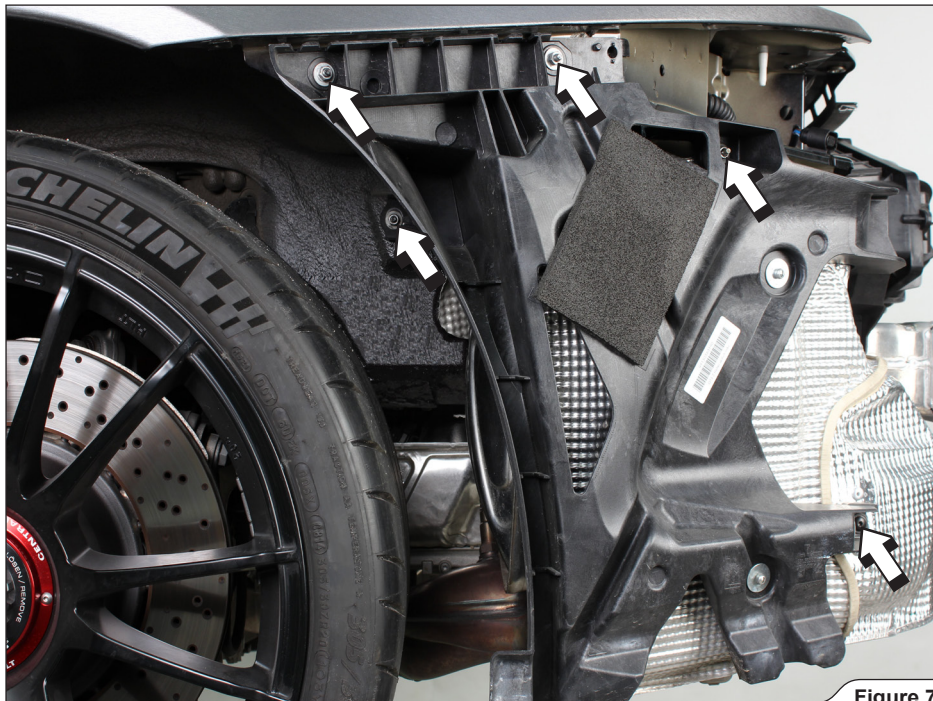

Figure 7

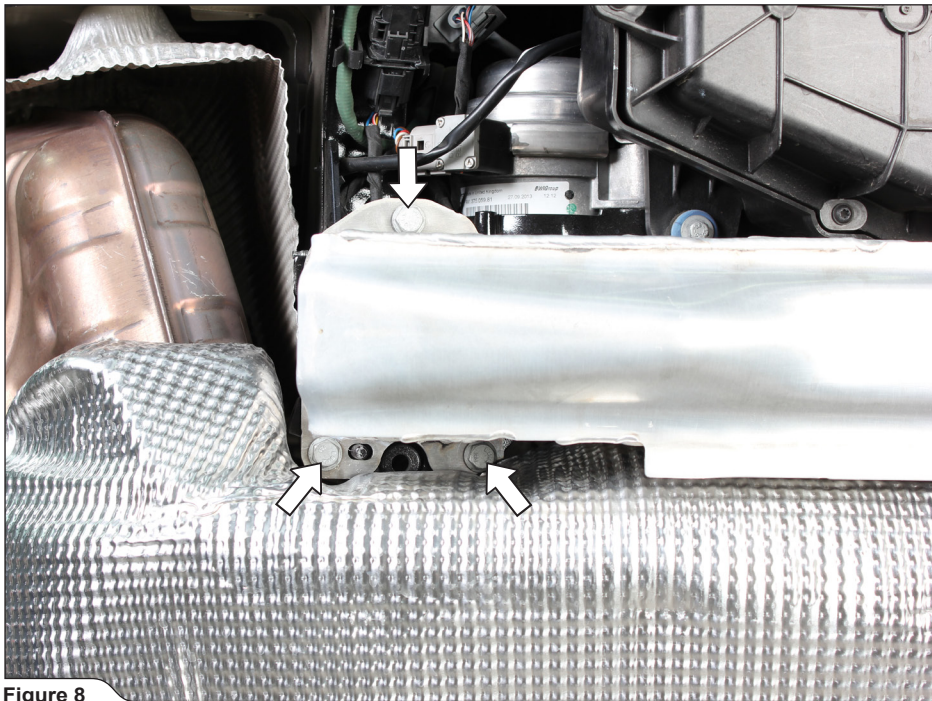

Figure 8

8. Unscrew the marked flange nuts and lambda sensors, carefully pull the vacuum hoses off the vacuum actuators, loosen and remove marked connection clamps, unscrew side-muffler's bracket bolts and carefully remove both side mufflers off the vehicle (**Figure 9, 10**).

! **CAUTION:** make sure not to injure yourself or damage any part of the vehicle during this process!

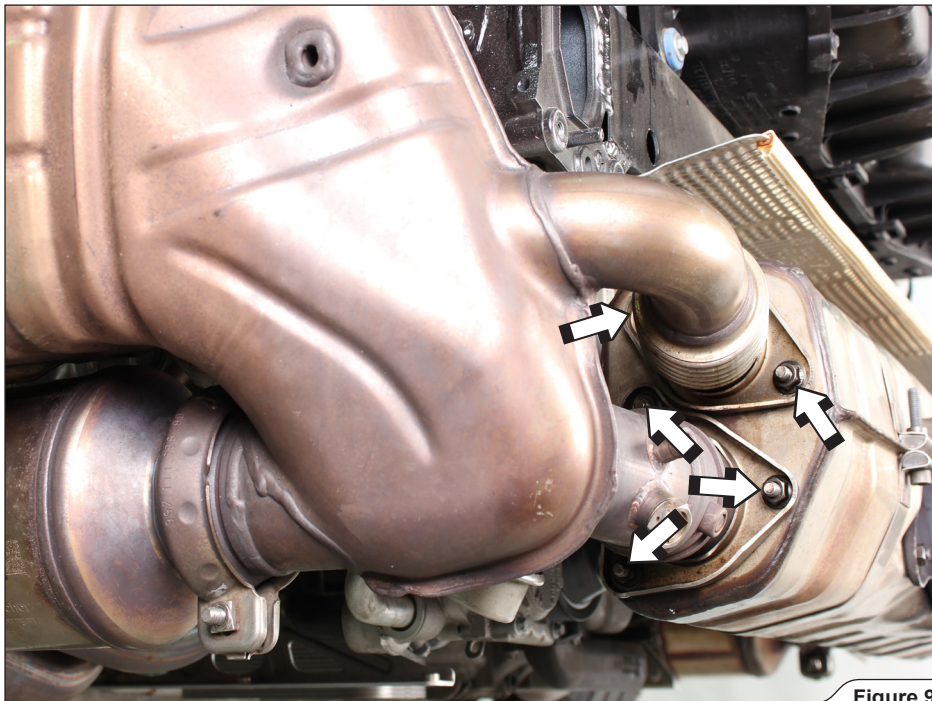

Figure 9

! CAUTION: make sure not to damage the sensors' electrical leads during this process!

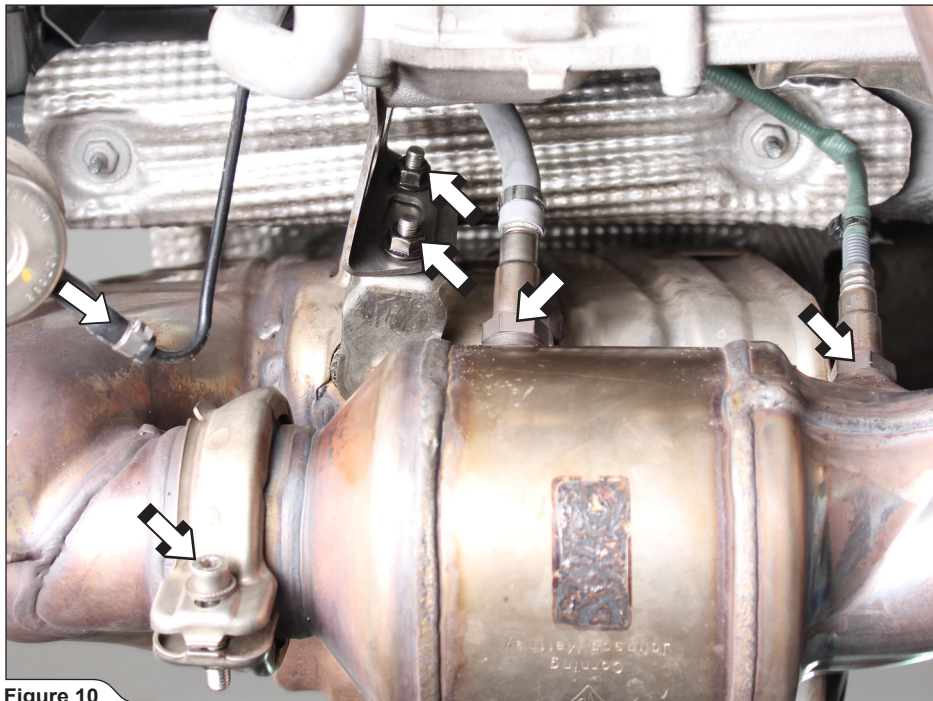

Figure 10

9. Unscrew marked flange bolts and carefully remove both headers off the vehicle (**Figure 11**).
! **CAUTION:** make sure not to damage the sensors' electrical leads during this process!

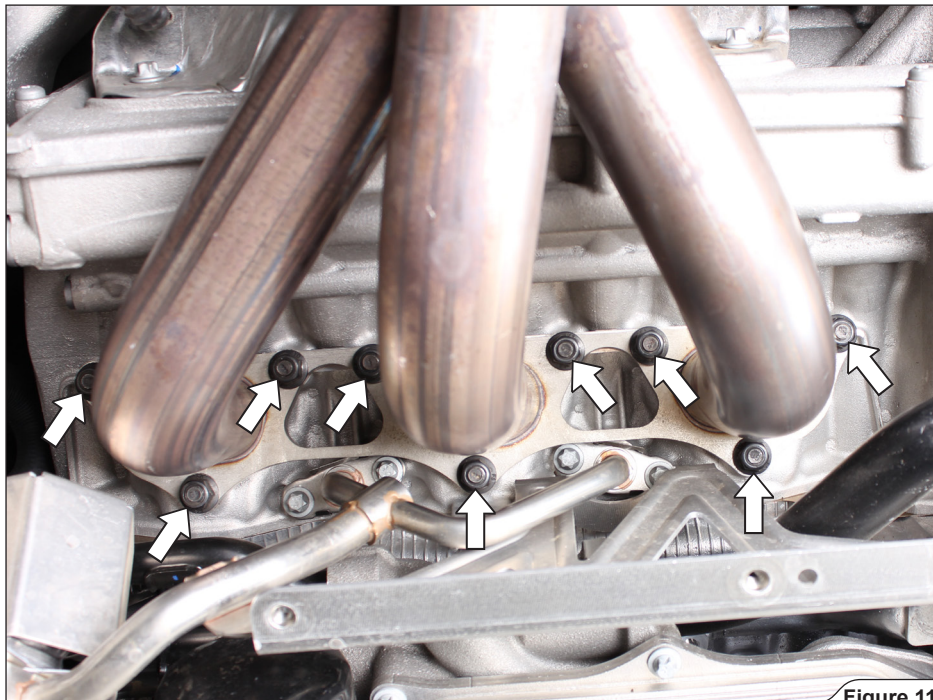

Figure 11

10. Unscrew the marked bolts and remove the central muffler with clamps off the vehicle (**Figure 12**).

! **CAUTION:** make sure, not to injure yourself or damage any part of the vehicle during this process!

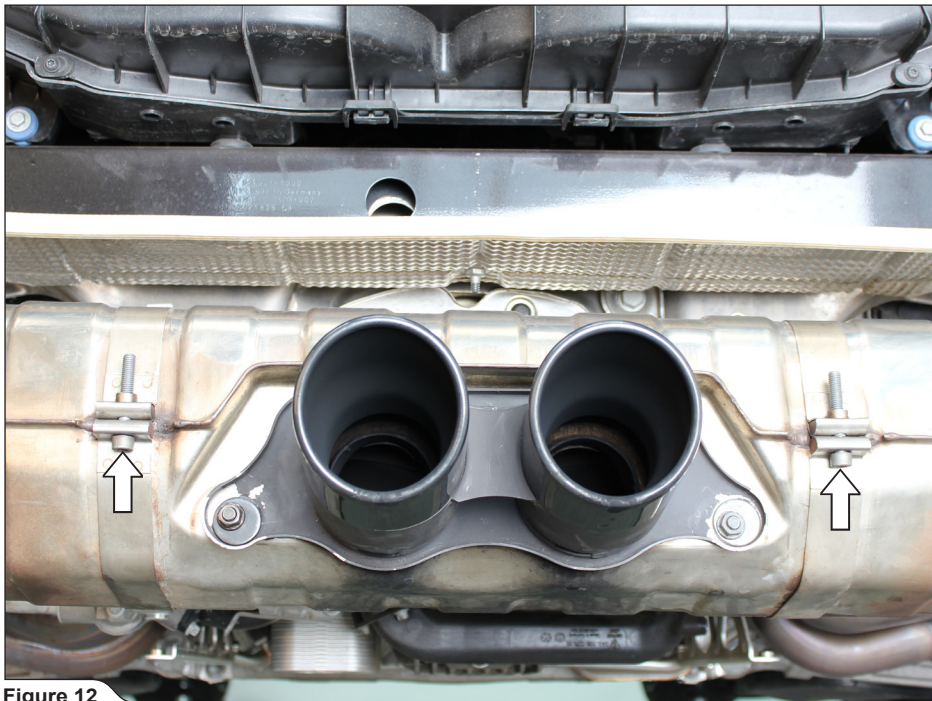

Figure 12

INSTALLATION OF THE AKRAPOVIČ EXHAUST SYSTEM:

1. Set left and right Akrapovič headers with new stock gaskets and hand tighten with all stock nuts first. Tighten nuts to a specified torque using criss-cross pattern in three steps (**Figure 13**).

! CAUTION: use new exhaust port gaskets!

! WARNING: use anti-seize copper paste on all bolt threads!

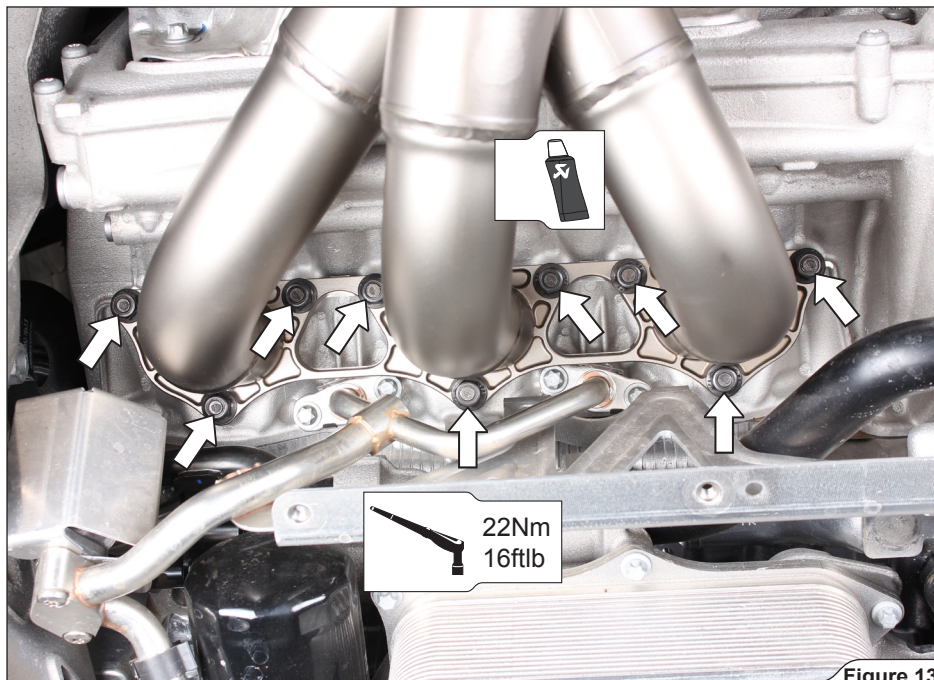

Figure 13

2. Attach lambda sensors on both sides of the vehicle (**Figure 14**).

! **WARNING:** use anti-seize copper paste only on sensors' threads!

! **CAUTION:** make sure not to damage the sensors' electrical leads during this process!

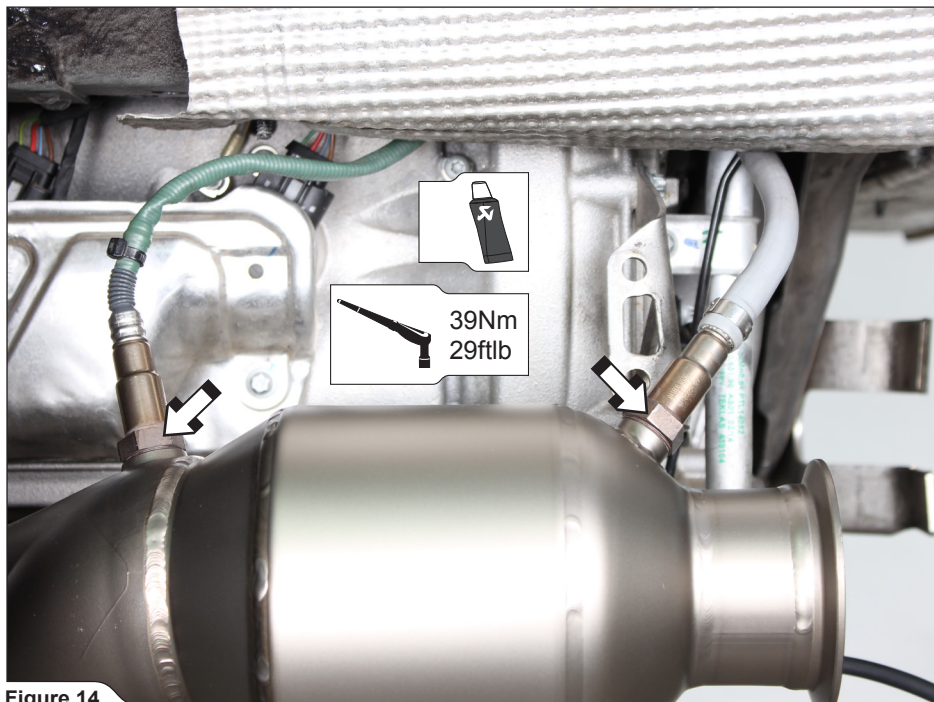

Figure 14

3. Install the clamps from Akrapovič installation kit onto the side muffler's and link-pipe's inlets as shown (Figure 15).

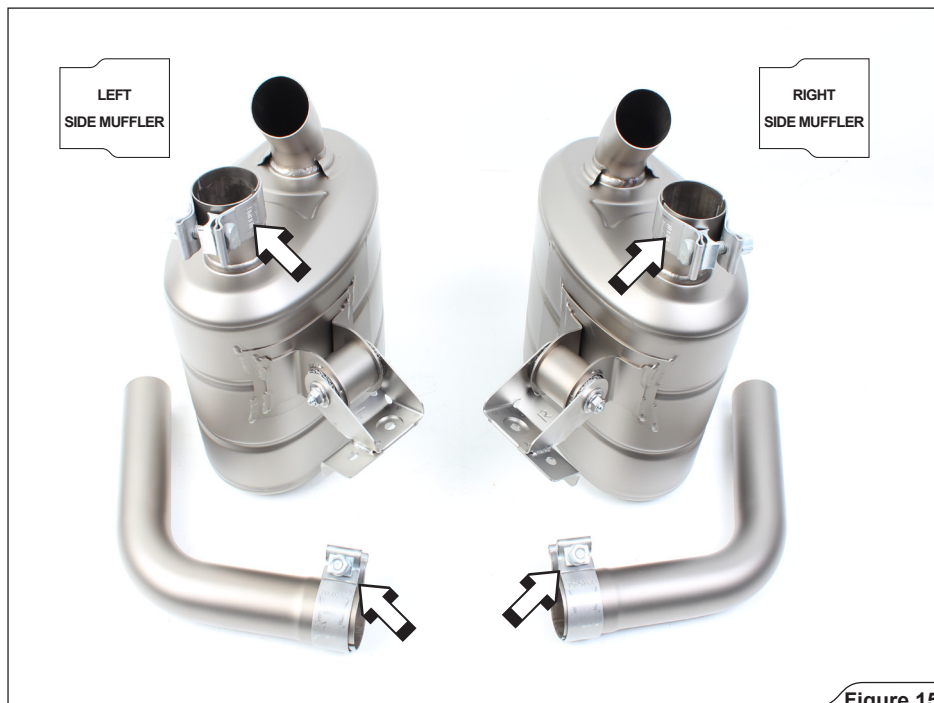

Figure 15

4. Correctly position and install right side muffler using bolts and nuts from Akrapovič installation kit, as shown. Hand tighten bracket bolts only (Figure 16).

! **WARNING:** use anti-seize copper paste on all bolt and nut threads!

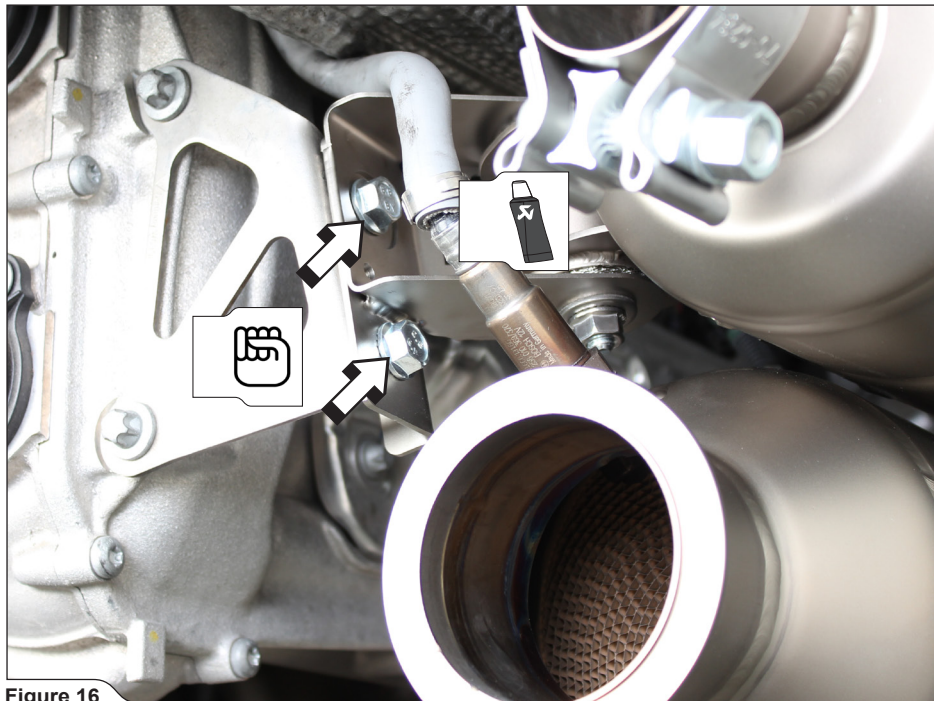

Figure 16

5. Remove stock rubber vacuum outlet tubes and install Akrapovič rubber vacuum tubes on both sides of the vehicle. Secure the connection using clamps from Akrapovič installation kit (**Figure 17, 18**).

! **WARNING:** direct the stock vacuum tube in such a way, that it doesn't touch any hot or moving parts!

! **CAUTION:** make sure, that stock vacuum tube is not bent or obstruct in any way!



Figure 17



Figure 18

- Secure the vacuum pipes using notched rubber tubes and plastic tie wraps from Akrapović installation kit, on both sides of the vehicle, as shown (Figure 19, 20).

! **WARNING:** direct the stock vacuum tube in such a way, that it doesn't touch any hot or moving parts!

! **CAUTION:** make sure, that stock vacuum tube is not bent or obstruct in any way!

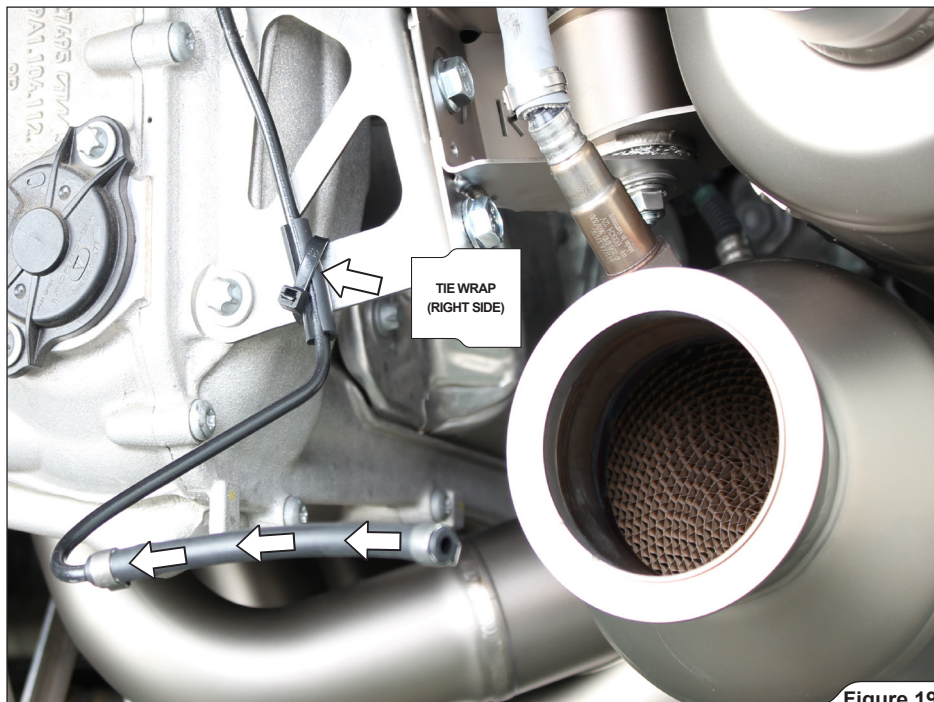

Figure 19

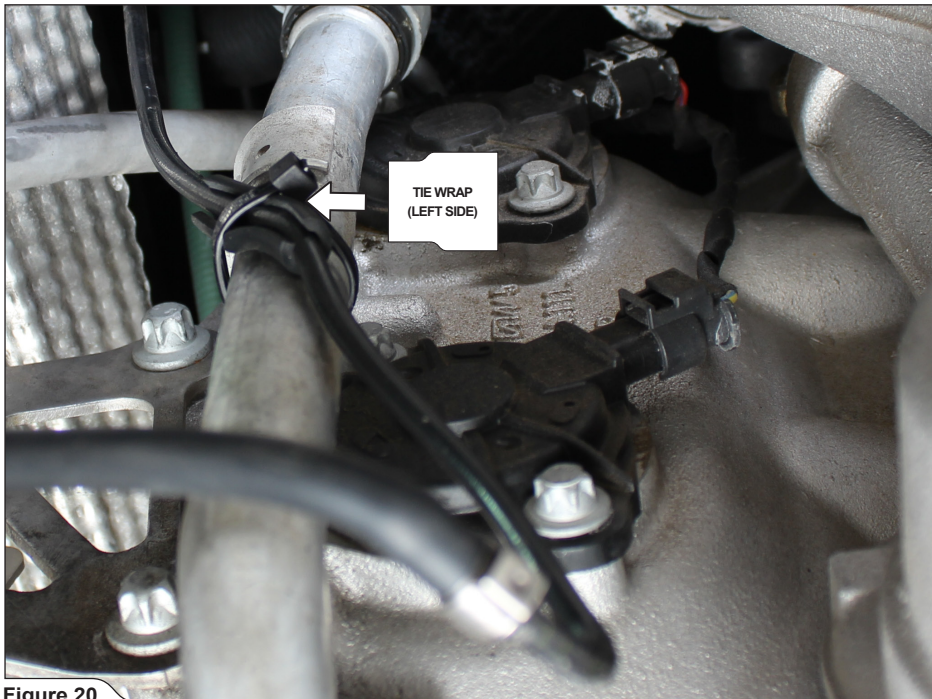

Figure 20

7. Install the V-clamps from Akrapovič installation kit onto the link-pipes inlets, as shown (**Figure 21**).



Figure 21

8. Position and install both right link-pipes and hand tighten the clamps only.
9. Correctly orient and attach right muffler flange and muffler's inlet gaskets, connect the vacuum tubes to the vacuum actuators, as shown (Figure 22).

! **CAUTION:** secure vacuum tubing connections, using clamps from Akrapovič installation kit! Install the clamps with corresponding tube clamp pliers.

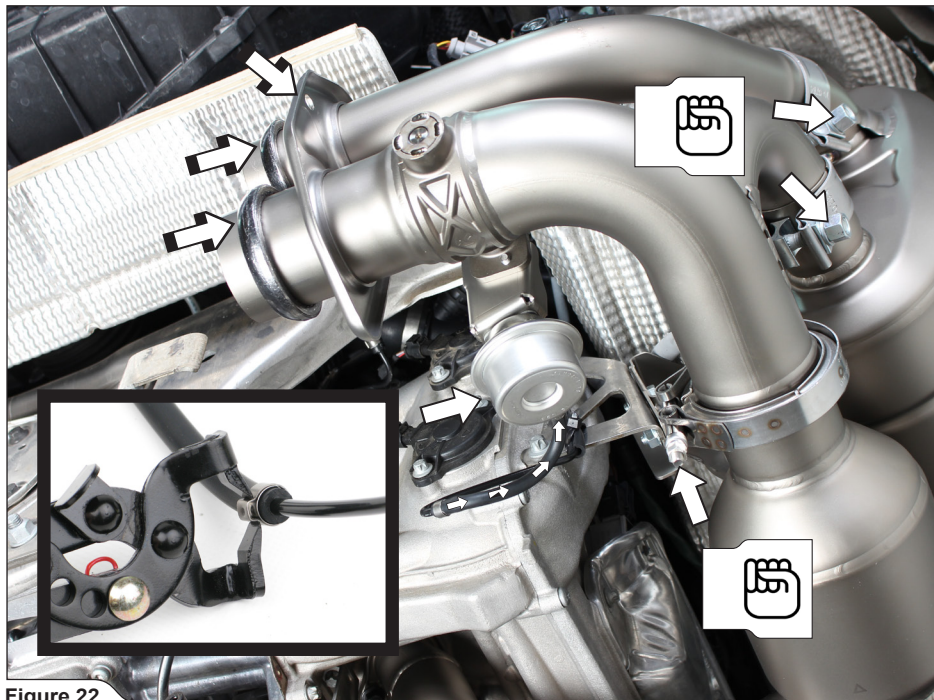

Figure 22

10. Assemble Akrapovič clamps on both side of the Akrapovič central muffler as shown (**Figure 23**).



Figure 23

11. Hang Akrapovič central muffler with clamps onto the vehicle brackets, insert link-pipes and hand tighten bolts and nuts (Figure 24).

! **WARNING:** use anti-seize copper paste on both clamp bolts and nut threads!

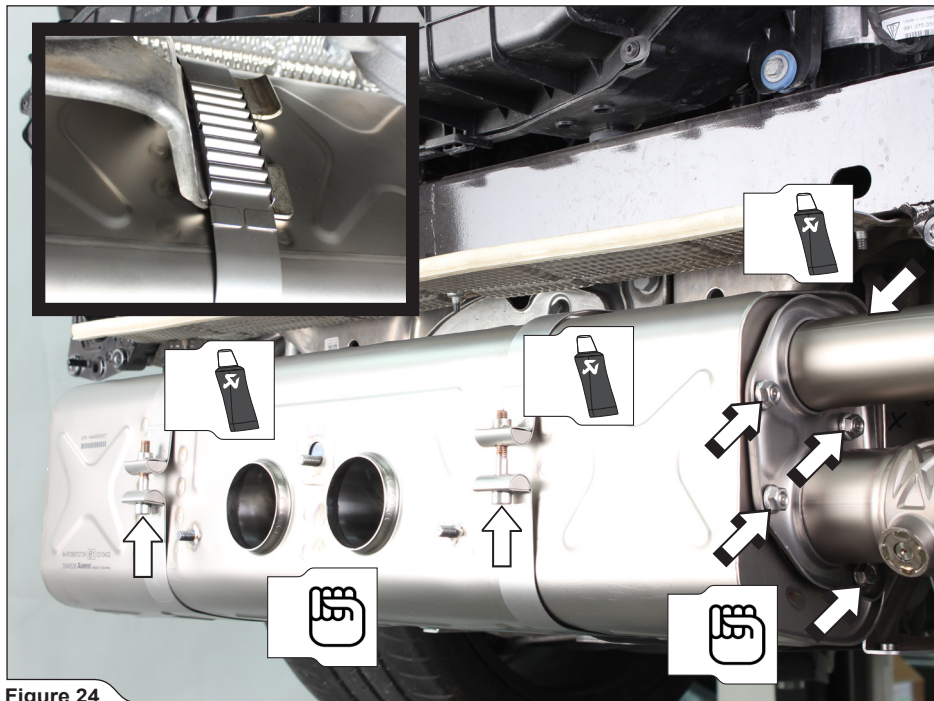

Figure 24

12. Assemble left side muffler with both link pipes. Correctly orient and attach central muffler flange and muffler's inlet gaskets, as shown. Hand tighten the clamps only (**Figure 25**).

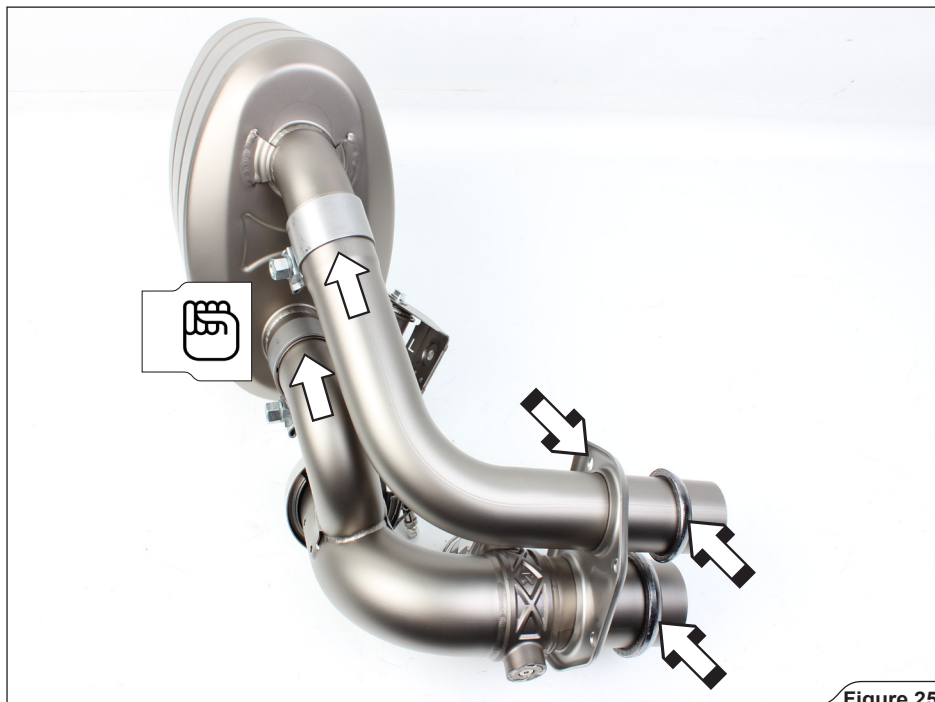

Figure 25

13. Correctly position and install left side muffler and simultaneously insert both link pipes into the central muffler's inlets. Hand tighten the nuts only (**Figure 26**).

! **WARNING:** use anti-seize copper paste on all bolt and nut threads!

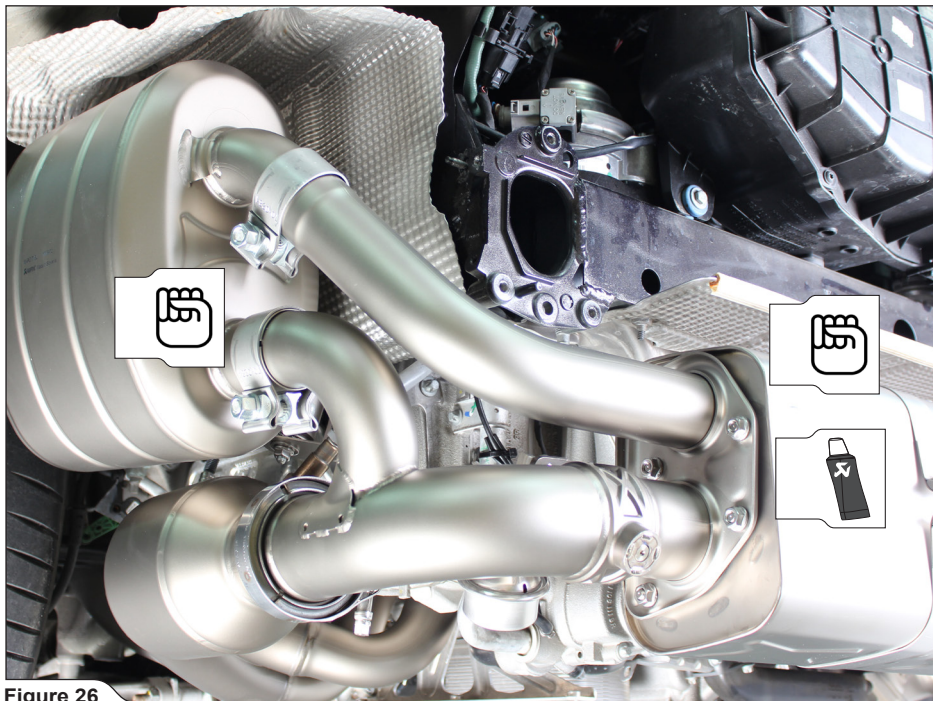

Figure 26

14. Connect the vacuum tubes to the vacuum actuators, as shown (Figure 27).

! **CAUTION:** secure vacuum tubing connections, using clamps from Akrapovič installation kit! Install the clamps with corresponding tube clamp pliers.

! **WARNING:** use anti-seize copper paste on bracket bolt threads!

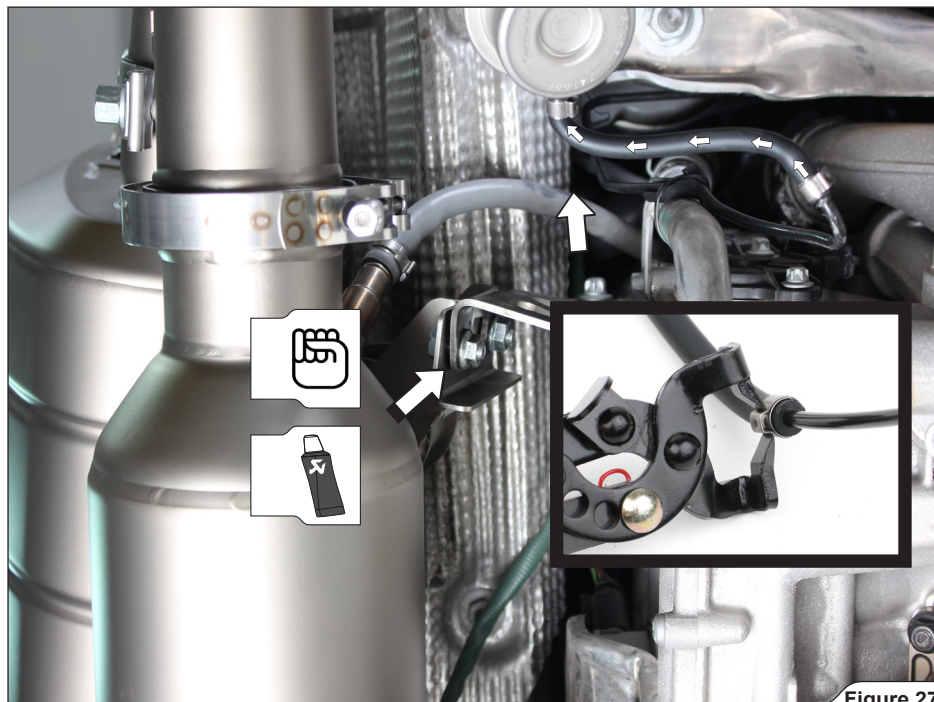

Figure 27

15. Align and center Akrapovič central muffler in respect to the vehicle and tighten the muffler clamps and flanges to the specified torques on both sides of the muffler (**Figure 28**).

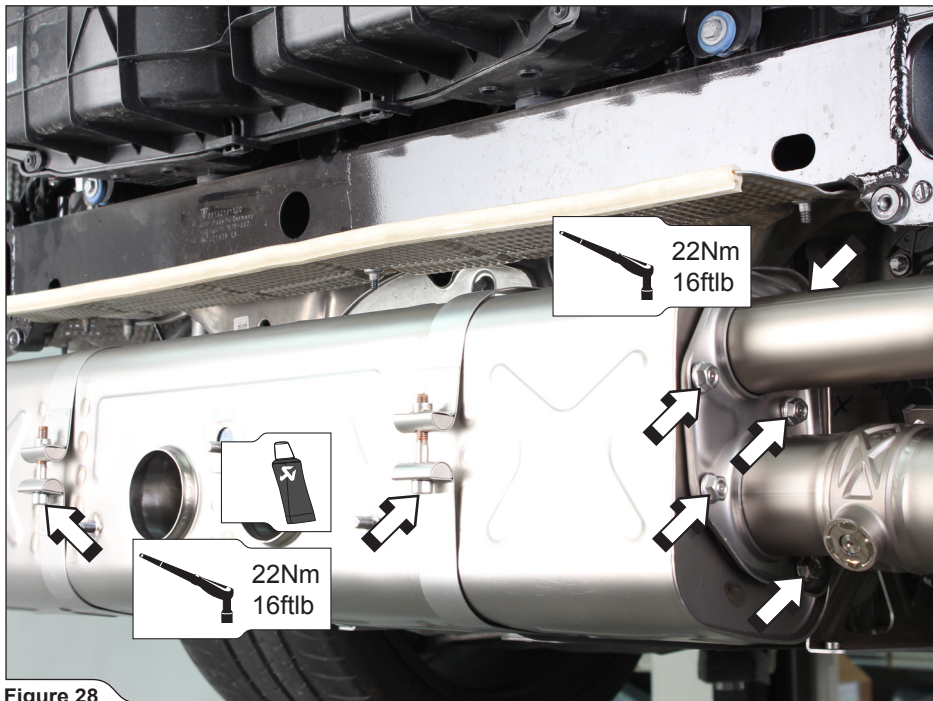

Figure 28

16. Correctly align and tighten side mufflers. Tighten the bracket bolts and connection clamps on both sides of the vehicle, to the specified torques (**Figure 29, 30**).

! **WARNING:** use anti-seize copper paste on all bolt threads!

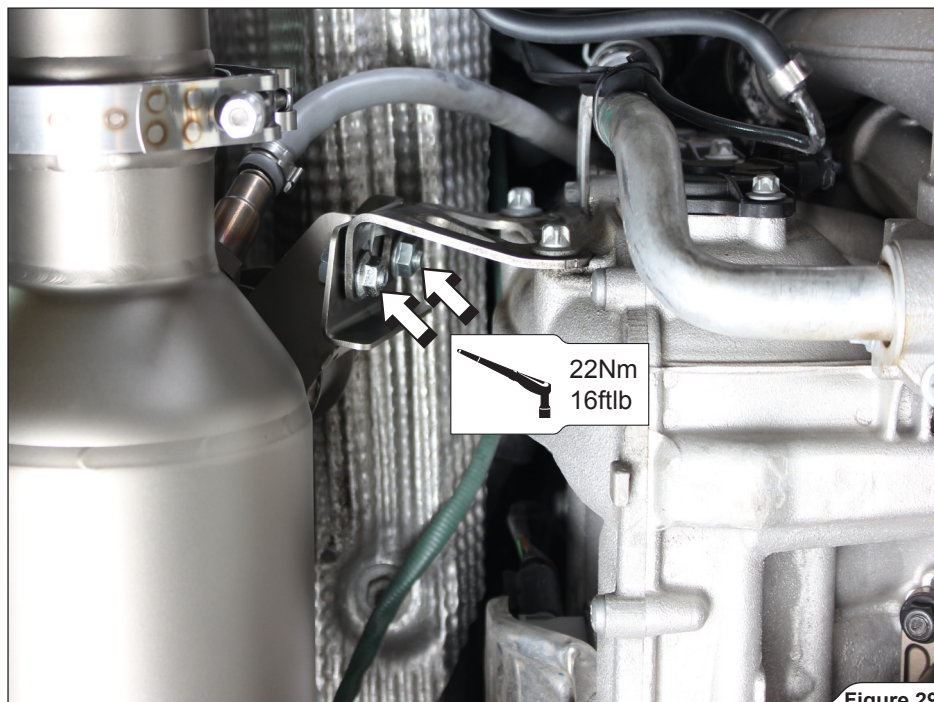

Figure 29

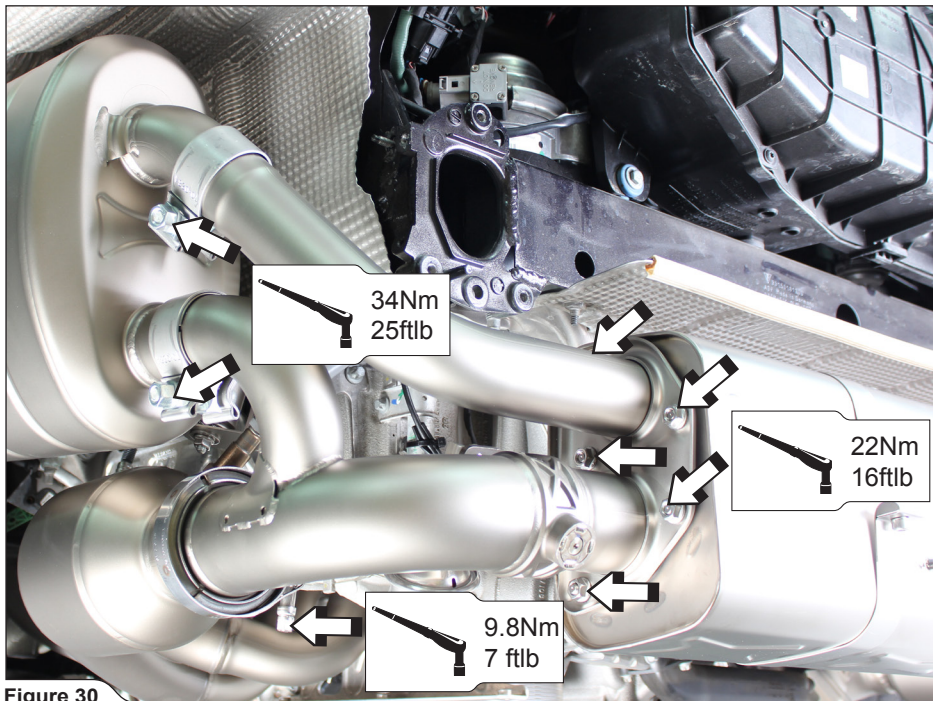

Figure 30

17. Attach Akrapovič tail-pipe onto the muffler's outlet. Correctly assemble and hand tighten nuts and centering washers from Akrapovič installation kit (**Figure 31**).

! **WARNING:** use anti-seize copper paste on all nut threads!

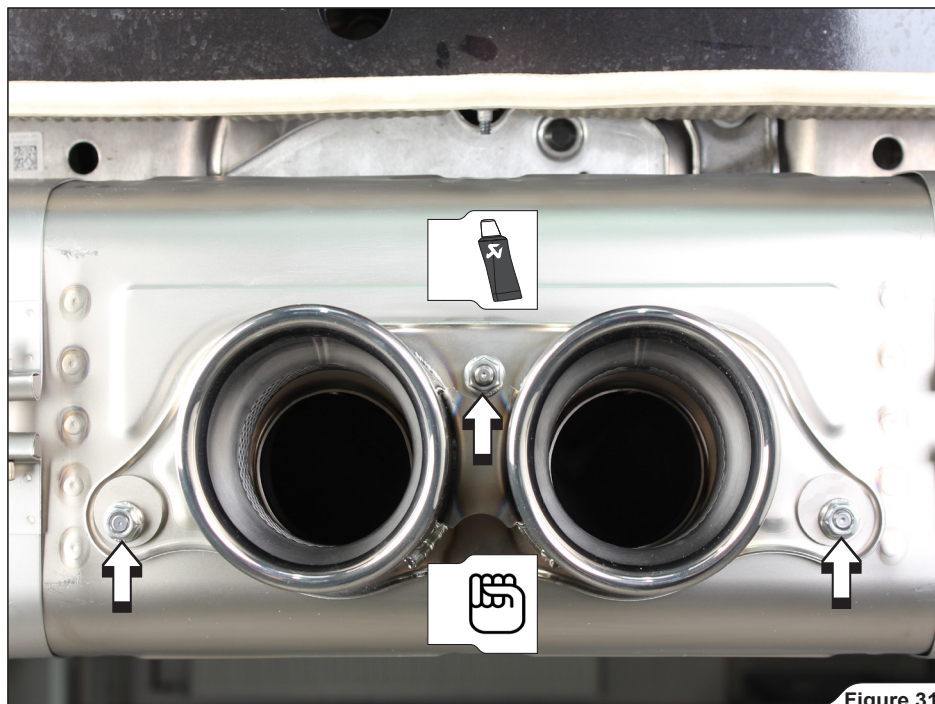

Figure 31

18. Replace all dismantled stock parts in the reverse order from the order in which they were removed. Check vehicle manufacturer manual for tightening torques.

! **CAUTION: make sure not to injure yourself or damage any part of the vehicle during this process!**

- Center the tail-pipe in respect to the rear bumper and tighten the nuts to the specified torque (Figure 32, 33).

! CAUTION: make sure not to injure yourself or damage any part of the vehicle during this process!



Figure 32

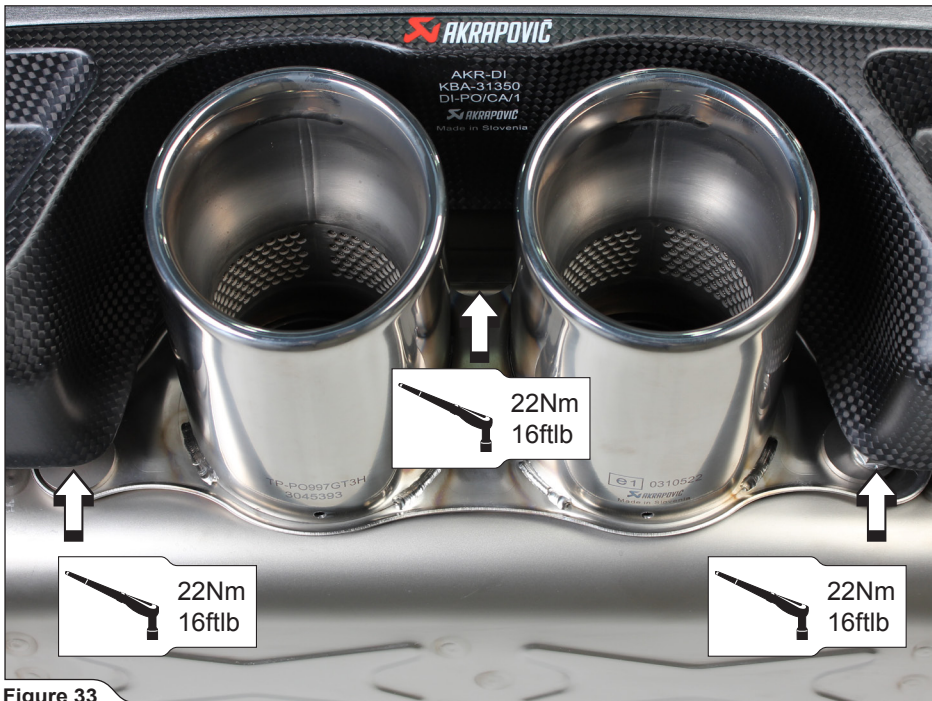

Figure 33

Final installation:

- ! **WARNING: check vehicle manufacturer manual for tightening torques (for dismantled stock parts)!**
- ! **WARNING: make sure all the nuts and bolts are sufficiently tightened. In case the exhaust system touches the cowling or other parts, repeat the adjustment of the exhaust system or contact your authorized dealer.**

MAINTENANCE OF THE AKRAPOVIČ EXHAUST SYSTEM:

1. Clean the titanium exhaust components with a multi-purpose spray lubricant (WD-40 or equivalent), carbon fiber exhaust components with soft and dry cloth and stainless steel components with soft cloth sprayed with contact cleaner, then wipe with soft and dry cloth. A change in the color of the exhaust system is normal due to high temperatures.
2. Periodically make sure all the bolts and springs are sufficiently tight.

! **WARNING: clean all exhaust components before the first start of the engine or the stains will burn onto the surfaces!**

! **IT IS NORMAL FOR WHITE SMOKE TO COME OUT OF THE MUFFLER AT FIRST OPERATION.**

! **DO NOT STAND BEHIND THE MUFFLER AT FIRST OPERATION.**

! **DO NOT USE AUTOMOTIVE WHEEL CLEANERS OR ANY CLEANING PRODUCTS WHICH CONTAIN ACIDIC ADDITIVES TO CLEAN THE AKRAPOVIČ EXHAUST SYSTEMS.**

WARNING

Please note that certain aftermarket exhaust systems may not comply with applicable California laws and regulations, and may therefore be prohibited for use on California highways or roads, or on roads or vehicles otherwise subject to emissions control requirements.

Akrapovič exhaust systems for automobiles and motorcycles mounted downstream of the catalytic converter (also known as “cat-back systems”) are considered “replacement parts” in California by the California Air Resources Board (CARB), and do not require an exemption or executive order from CARB to be sold in California. However, California prohibits the use of any aftermarket exhaust system that modifies, removes or replaces original equipment catalysts, unless CARB has issued an Executive Order as to such part or system.

Further, Akrapovič parts or exhaust systems used or intended for use on “racing vehicles” (i.e. a competition vehicle used exclusively for competition on closed-course circuits) do not require an exemption or Executive Order from CARB to be sold in California. However, such parts are prohibited from use on California public highways or roads, even if occasionally used “off-road.”

www.akrapovic.com

