



## Installation instructions

Akrapovič Exhaust System:  
**Evolution**  
for the  
**Mercedes-AMG S63 Coupe** (type C 217)

ENGLISH  
Version 1.0

11/2015

[www.akrapovic.com](http://www.akrapovic.com)





## Installation instructions

Akrapovič Exhaust System:

**Evolution**

for the

**Mercedes-AMG S63 Coupe** (type C 217)

ENGLISH

Version 1.0

11/2015

[www.akrapovic.com](http://www.akrapovic.com)

Congratulations on purchasing the Akrapovič exhaust system. The Akrapovič exhaust system is a product of Akrapovič d.d., Malo Hudo 8a, 1295 Ivančna Gorica, Slovenia ("Akrapovič").

**Please read this entire installation manual carefully prior to installing and using the Akrapovič exhaust system.**

Please entrust the installation of the Akrapovič exhaust system to a trained professional skilled in car knowledge / motorcycle knowledge of exhaust system installation and performance. The instructions provided in this manual should be followed to ensure proper installation and safe use of the Akrapovič exhaust system. Akrapovič and/or its partners shall not be held liable for any damage or personal injury (including direct, indirect, or consequential damage) sustained as a result of improper installation of the Akrapovič exhaust system, use contrary to the instructions and warnings contained herein.

If you have any questions regarding the installation and/or proper use of the Akrapovič exhaust system or these instructions, contact your local authorized Akrapovič partner.

For more information on the Akrapovič exhaust systems, see the official Akrapovič website at: <http://www.akrapovic.com>

## **GENERAL INFORMATION**

All statements made with regard to the exhaust system's compliance are made in respect of the exhaust system "as is". Any modifications of the Akrapovič exhaust system or its improper installation that is not in accordance with these Installation Instructions, may result in severe damage to the exhaust system and/ or engine, as well as personal injury, and may affect the exhaust system's compliance with the legal requirements, such as exhaust system's air and/ or noise emissions (as an example, the motorcycle may not be used on public roads any longer). Please make sure that the exhaust system is used only in accordance with all relevant laws and regulations, including state and federal, where applicable.

## **GENERAL WARNING**

Because of the world-wide distribution of Akrapovič d.d. products, neither Akrapovič d.d. nor any of its subsidiaries make any representation that the products comply with the air and/or noise emissions laws, or labeling laws, of any jurisdiction. The purchasers are entirely responsible for informing themselves of the applicable laws where the products are to be used and to comply with those law.

## **COPYRIGHT AND OTHER RIGHTS NOTICE**

The Akrapovič trademark, including corporate logos and emblems, are subject to copyright as well as trademark rights of Akrapovič, its licensors, or third persons authorizing Akrapovič to use them.

## **REGISTERED COMMUNITY DESIGN**

RCD 002747105-0001

Any reproduction, technical or other manipulation, translation, or other use of the copyright and/or trademark rights contained herein is prohibited without the explicit prior written consent of Akrapovič. The same especially applies to the entire contents of this manual and/or any of its parts, including but not limited to technical specifications, instructions, graphs, photographs, and so on included in this manual.

The photographs and other illustrations in this manual are symbolic and are intended to help represent individual steps for proper installation and use, as well as for a general overview. The actual component parts of the Akrapovič exhaust system may not entirely correspond to the photographs and other illustrations.

© Akrapovič d.d., 2015, All rights reserved.

## CA-WARNING:

Please note that certain aftermarket exhaust systems may not comply with applicable California laws and regulations, and may therefore be prohibited for use on California highways or roads, or on roads or vehicles otherwise subject to emissions control requirements.

Akrapovič exhaust systems for automobiles and motorcycles mounted downstream of the catalytic converter (also known as “cat-back systems”) are considered “replacement parts” in California by the California Air Resources Board (CARB), and do not require an exemption or executive order from CARB to be sold in California. However, California prohibits the use of any aftermarket exhaust system that modifies, removes or replaces original equipment catalysts, unless CARB has issued an Executive Order as to such part or system. Further, Akrapovič parts or exhaust systems used or intended for use on “racing vehicles” (i.e. a competition vehicle used exclusively for competition on closed-course circuits) do not require an exemption or Executive Order from CARB to be sold in California. However, such parts are prohibited from use on California public highways or roads, even if occasionally used “off-road.”

## USA WARNING

Various U.S. states and the U.S. federal government have individual laws regulating the use of aftermarket exhaust parts and systems, especially as those parts and systems modify, remove, or replace original equipment catalysts. Please consult the appropriate laws in your area before installing any aftermarket part or system on your vehicle to ensure compliance with all applicable laws. Neither Akrapovic d.d., Akrapovic America LLC nor any of their subsidiaries or the sellers of the parts or systems make any representation that any of their parts or systems comply with any such laws.

## IMPORTANT INFORMATION

### Exclusion of Certain Liability

1. Akrapovič makes no representation or warranties with regard to damage caused by the improper installation, use and maintenance of the Akrapovič exhaust system. The warranty is limited to defects recognized by our technical department and due to normal use, and excludes items subject to normal wear (gaskets and damping wool). The guarantee is void in case of accident, modification, improper or competition use.
2. Do not attempt to install the Akrapovič exhaust system on a vehicle model for which it was not made or tested by Akrapovič.
3. When the exhaust system gets very hot during operation, be careful not to burn yourself on the exhaust system or parts which are in direct contact with it, even when the engine is not running. Also protect other people, especially children, from the injuries mentioned above.
4. In some cases Akrapovič exhaust system kits contain chemical products (ceramic anti-seizing grease; bolt sealant). Handle with care, do not inhale or swallow. Avoid excessive contact with skin, eyes or mucous membranes. Keep out of reach of children.
5. Technical specifications of Akrapovič exhaust systems and related products are subject to change without notice.
6. Before removing the original exhaust system from your vehicle, please compare the parts you received with the list of materials provided on official Akrapovič website [www.akrapovic.com](http://www.akrapovic.com) in order to assure that you have all the parts necessary for the installation of your new Akrapovič exhaust system.
7. The process of uninstalling the original exhaust system may vary depending on the existing exhaust system. Please follow the original exhaust system manufacturer's instructions for uninstalling the original exhaust system.

## SYMBOLS

The following symbols are used throughout these installation instructions:



**TOOLS AND PROTECTIVE  
EQUIPMENT REQUIRED**



**TIGHTENING TORQUE**



**LUBRICATION**



**HAND TIGHTEN**



**INSTALLATION TIP**



**CAUTION OR IMPORTANT**

### USE BOLT SEALANT



Apply 3 to 4 small drops of bolt sealant onto the cleaned and degreased threads before tightening the bolts.

**WARNING! Avoid contact with skin, eyes and mucous membranes. Do not inhale fumes. Keep out of reach of children.**

### USE ANTI-SEIZE LEAD-FREE COPPER PASTE (black tube)



Provides trouble-free and long-lasting protection against seizing, corrosion and rusting of bolts, threaded ends, nuts, joints, etc. Also protects against vibration, wear and impact. **WARNING! Avoid eye contact. Avoid excessive skin contact. Keep out of reach of children.**

### USE ANTI-SEIZING GREASE (white tube)



Prevents seizing, corrosion and excessive wear between the titanium components of your exhaust system. **WARNING! Avoid eye contact. Avoid excessive skin contact. Keep out of reach of children.**



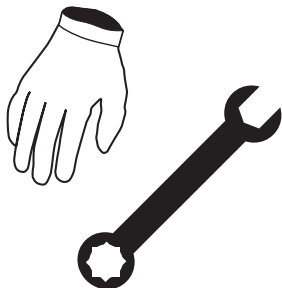

### Tools & equipment

- mechanic gloves
- eye protection
- Pipe cutting tool
- Torx 20
- Torx 40
- Torx 50
- Torx E14
- Socket 16 mm
- T-handle 8 mm wrench
- T-handle 10 mm wrench
- Pry bar
- Flat screwdriver
- Cutting nippers



**BEFORE INSTALLING, CHECK SCHEMATIC OF THE EXHAUST SYSTEM! THE LATEST VERSION OF THE PARTS LIST AND SCHEMATIC DRAWINGS OF THE PRODUCTS ARE AVAILABLE ON OUR WEB PAGE.**



**IF ANY ITEMS IN THE AKRAPOVIČ EXHAUST SYSTEM PACKAGE ARE MISSING, PLEASE CONTACT YOUR AUTHORIZED DEALER. KEEP THE SCHEMATIC FOR FUTURE REFERENCE.**



**THESE INSTALLATION INSTRUCTIONS MUST BE READ CAREFULLY IN ORDER TO ENSURE PROPER INSTALLATION AND OPERATION OF THE AKRAPOVIČ EXHAUST SYSTEM.**



**THE EXHAUST SYSTEM CAN BE EXTREMELY HOT. ALLOW THE EXHAUST AND ENGINE TO COOL DOWN BEFORE BEGINNING INSTALLATION.**



**WE ADVISE YOU TO LEAVE INSTALLATION TO A QUALIFIED SERVICEMAN. IMPROPER INSTALLATION MAY RESULT IN A SHORTER LIFETIME OF THE EXHAUST SYSTEM AND/OR DAMAGE TO THE VEHICLE.**



**THIS MANUAL IS SPECIFIC TO THE MERCEDES-AMG S63 COUPE TYPE C 217. THERE MAY BE SOME DIFFERENCES IN INSTALLATION PROCEDURES FOR OTHER MODELS.**



**WHEN INSTALLING AKRAPOVIČ'S AFTERMARKET OPTIONAL DOWN PIPES WITHOUT CATALYTIC CONVERTERS, WHICH ARE DEVELOPED FOR USE ON CLOSED TRACKS ONLY, REMAPPING OF THE ECU IS MANDATORY. THE AKRAPOVIČ COMPANY TAKES NO RESPONSIBILITY FOR ECU REMAPPING OR ANY POTENTIAL ISSUES RELATED TO THE USE OF AKRAPOVIČ DOWN PIPES.**



**AT EACH ENGINE START, THE EXUP VALVE MAY VIBRATE FOR A FEW SECONDS UNTIL THE VACUUM SYSTEM REACHES OPERATING PRESSURE.**

## REMOVAL OF STOCK EXHAUST SYSTEM:

Put the vehicle onto a car lift.

- ! **CAUTION:** ensure that the car is lifted safely and properly in order to avoid the risk of vehicle damage, injury, or even death!

1. Loosen the marked clamp and mark the left down pipe exactly as shown (243mm/9,57in from the rubber bracket). Carefully cut the pipe at the marked cutting line, using pipe cutting tool or equivalent (F 01).

- ! **CAUTION:** make sure not to injure yourself or damage any part of the vehicle during this process!

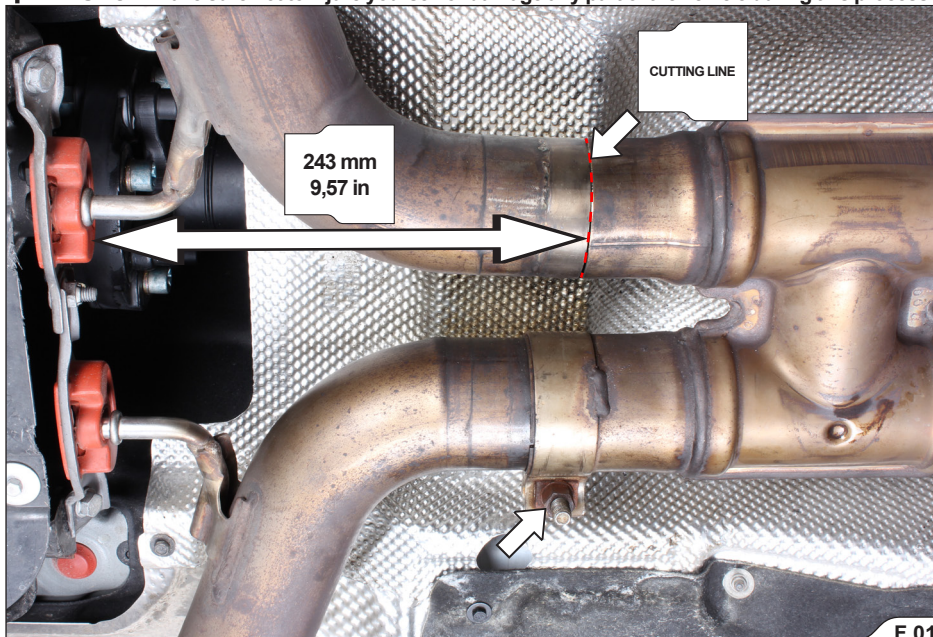

F 01

2. Unscrew the marked bolts and remove the chassis reinforcement (F 02).

! **CAUTION:** make sure not to injure yourself or damage any part of the vehicle during this process!

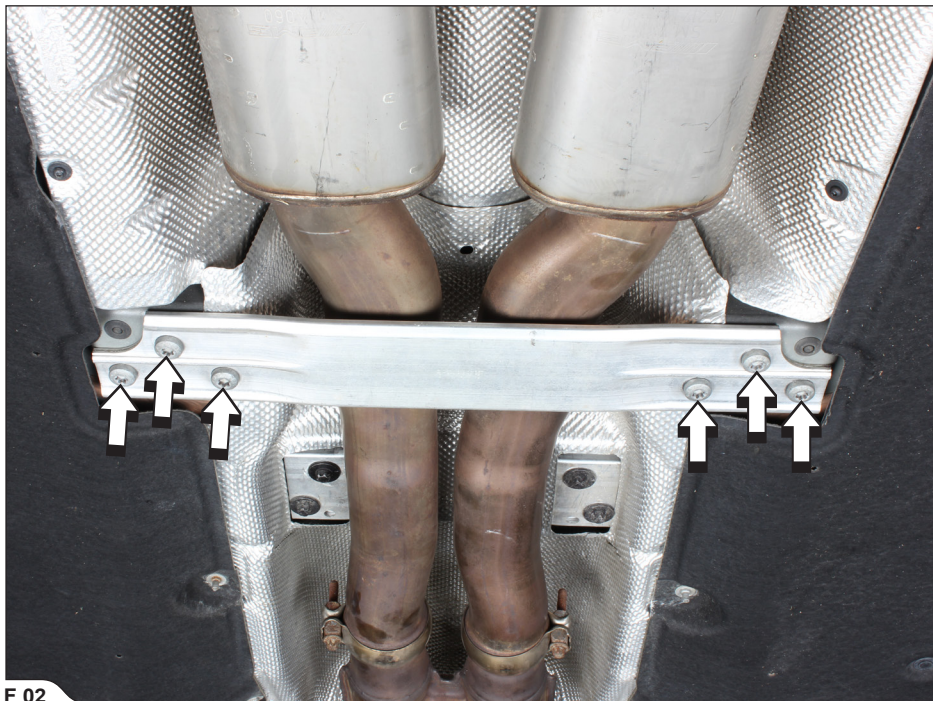

F 02

3. Unscrew the marked bolts and nuts; remove the rear underfloor panel (F 03).

! **CAUTION:** make sure not to injure yourself or damage any part of the vehicle during this process!

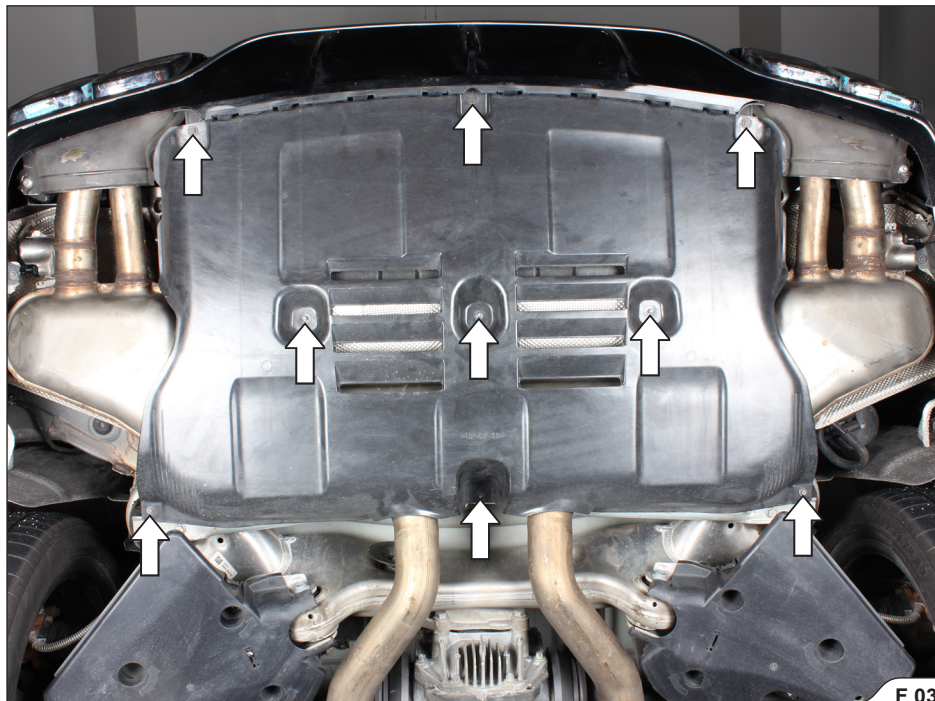

F 03

4. Disconnect the exhaust valve servos' connectors (F 04, 05)

! **IMPORTANT:** make sure, that car key is in OFF position, at least for 2 minutes, before you unplug the connectors!

! **IMPORTANT:** do not put the car key in ON position, or start the car, before all connectors are plugged again. Risk of check light on the dashboard!

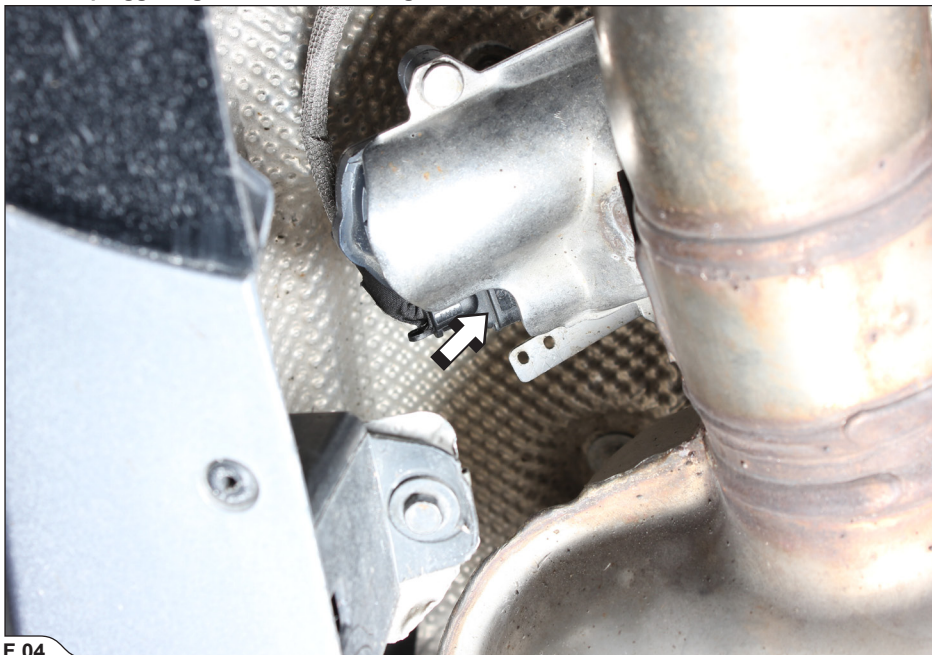

F 04

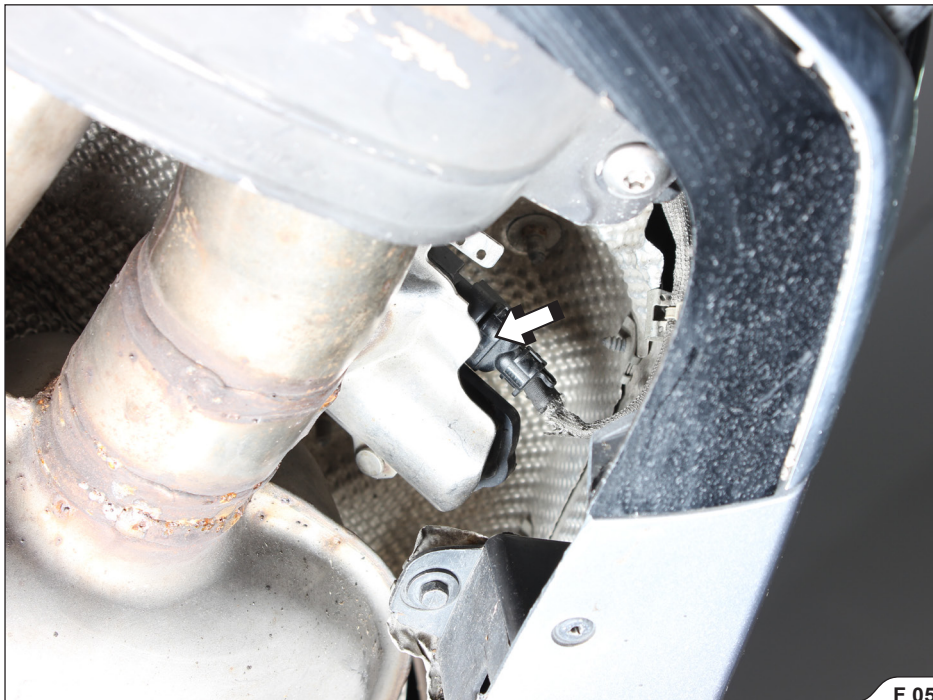

F 05

5. Support the muffler, unscrew the front rubber brackets, carefully pull the rear rubber brackets off the pins and carefully remove the stock exhaust system off the vehicle (F 06, 07, 08, 09).

! **CAUTION:** support the muffler during this process or you could injure yourself or damage the vehicle!

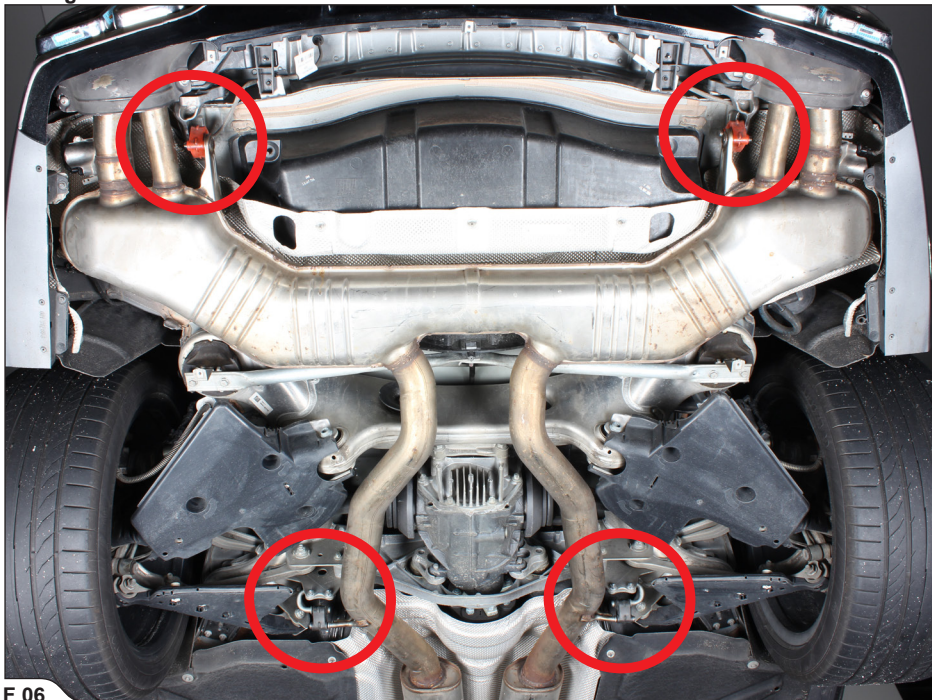

F 06

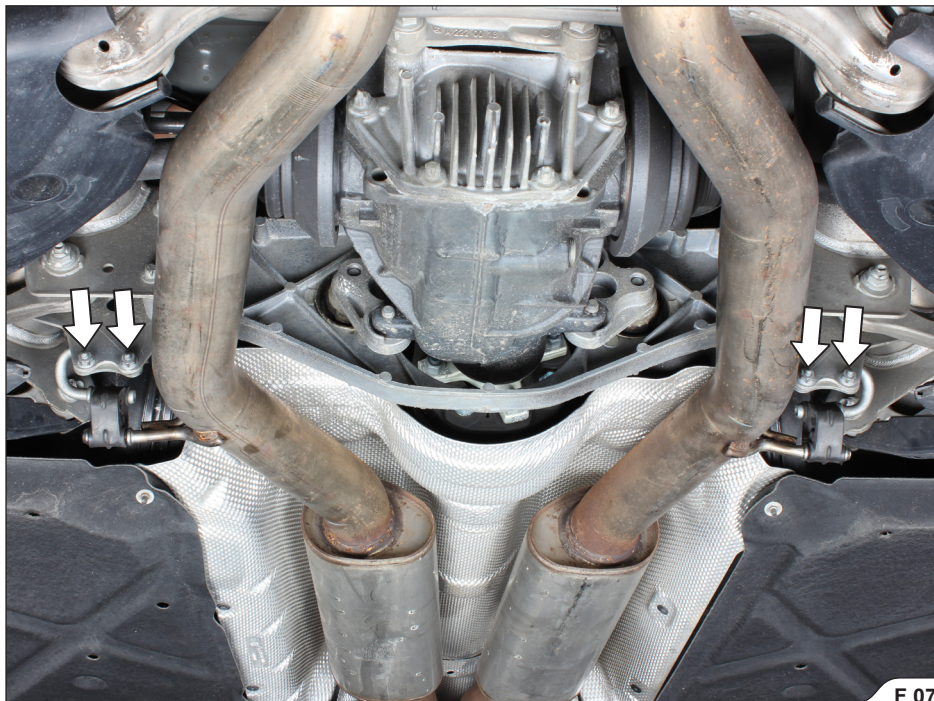



**✂** **INSTALLATION TIP:** for easier dismounting, lubricate the rubber brackets (WD40).

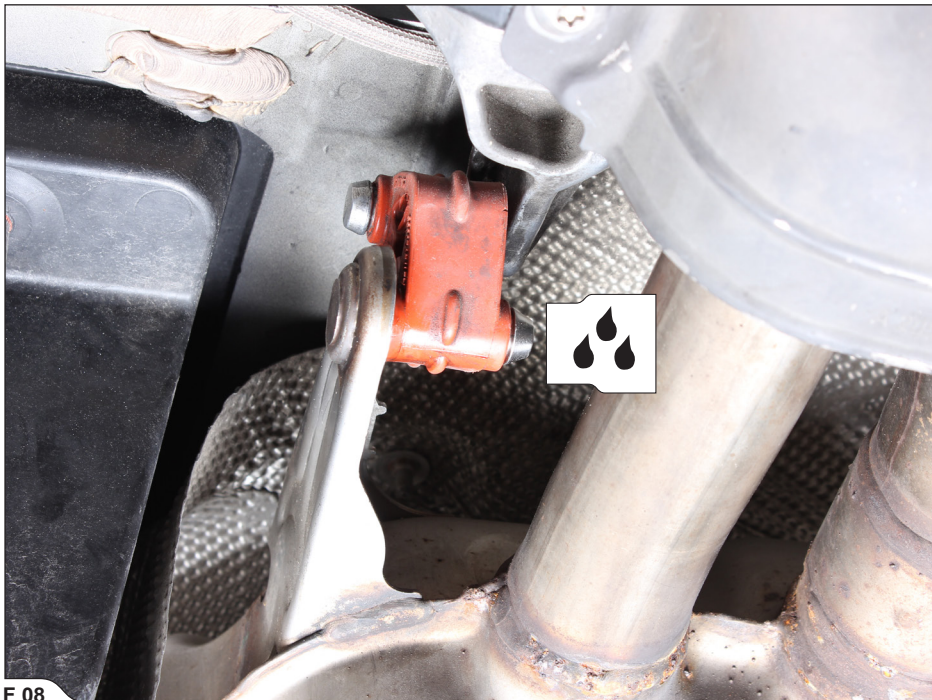

F 08

**W** **INSTALLATION TIP:** for easier dismounting, lubricate the rubber brackets (WD40).

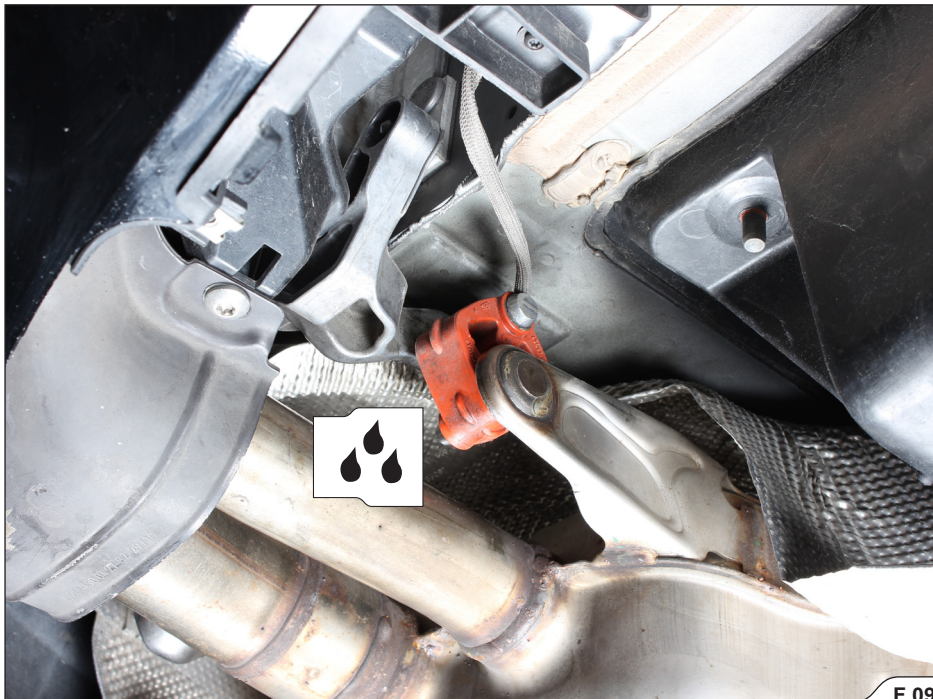

F 09

6. Unscrew the marked bolts and nuts, undo the plastic fasteners and carefully remove the left side underfloor panel (F 10).

! **CAUTION:** make sure not to injure yourself or damage any part of the vehicle during this process!

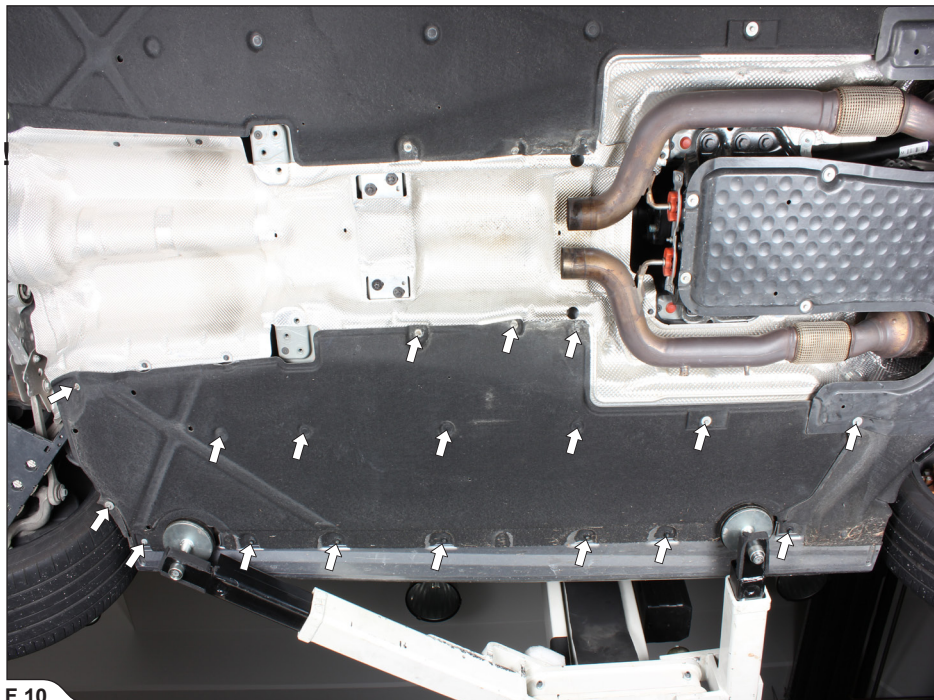

F 10

7. Unscrew and remove both tail pipes off the bumper (F 11).

! **CAUTION:** make sure, not to damage the bumper or tail pipes during this process!



F 11

8. Unscrew the marked bolts and nuts and carefully remove the heat protection off the vehicle (F 12).

! **CAUTION:** make sure not to injure yourself or damage any part of the vehicle during this process!

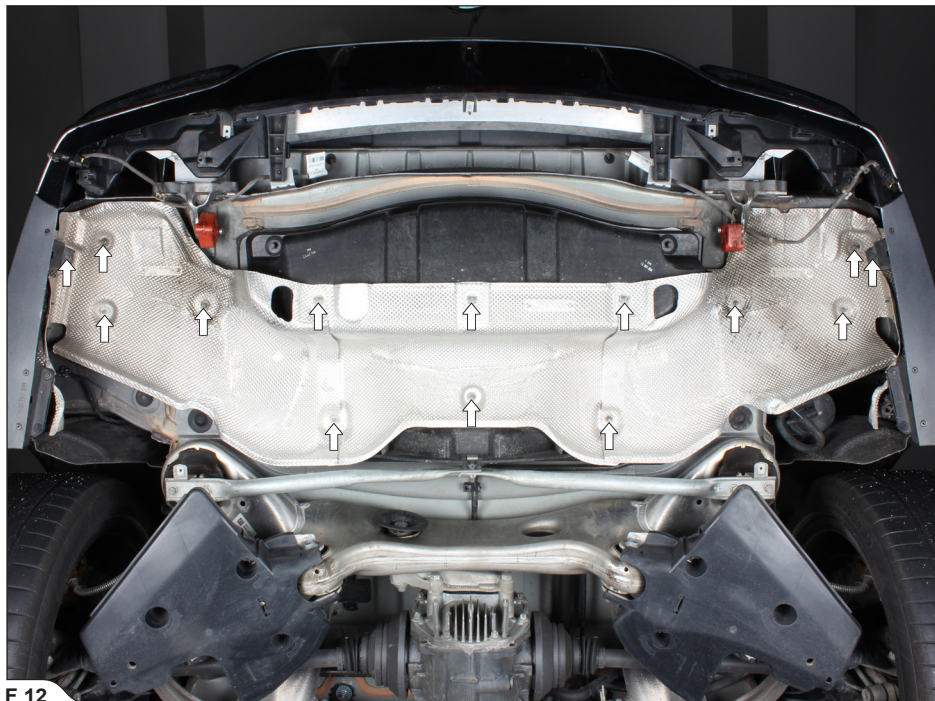

F 12

9. Unscrew both exhaust valves servos and carefully remove the rubber brackets off the exhaust system (F 13, 14).

**✂** **INSTALLATION TIP:** for easier dismounting, lubricate the rubber brackets (WD40).

**!** **CAUTION:** make sure not to injure yourself or damage any part of the exhaust system during this process!

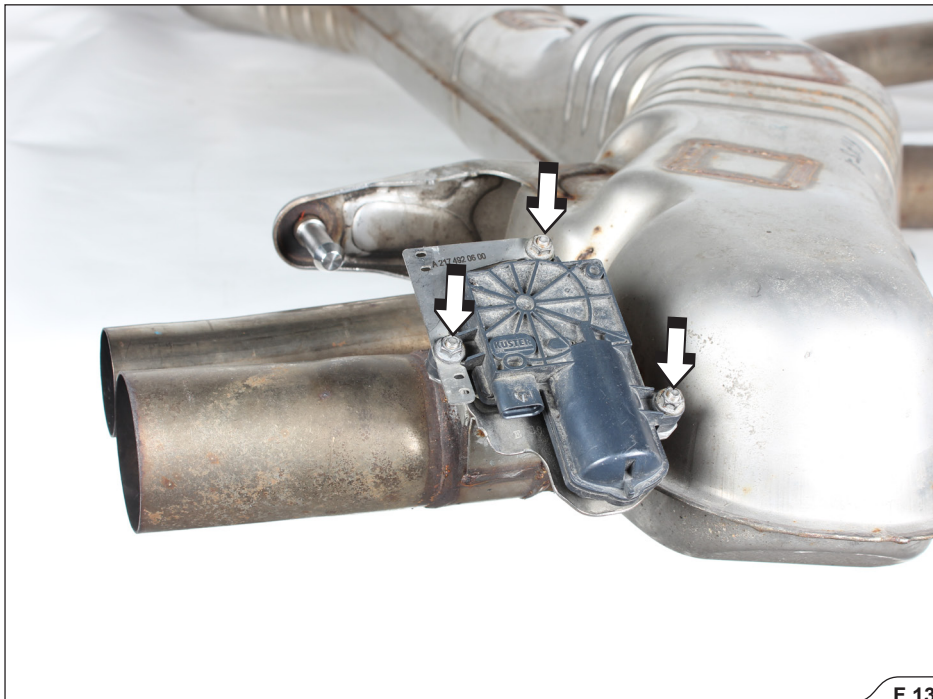

F 13



F 14

10. Remove the trunk floor panel and trunk trim panels to get access to electrical wiring harness in the trunk; check vehicle manufacturer manual for correct trunk panels disassembly (F 15).

**!** CAUTION: make sure not to injure yourself or damage any part of the vehicle during this process!



F 15



11. Cut the marked tie wraps and partially move the electrical harness cover out of the way (F 16).

! CAUTION: make sure not to injure yourself or damage any part of the vehicle during this process!

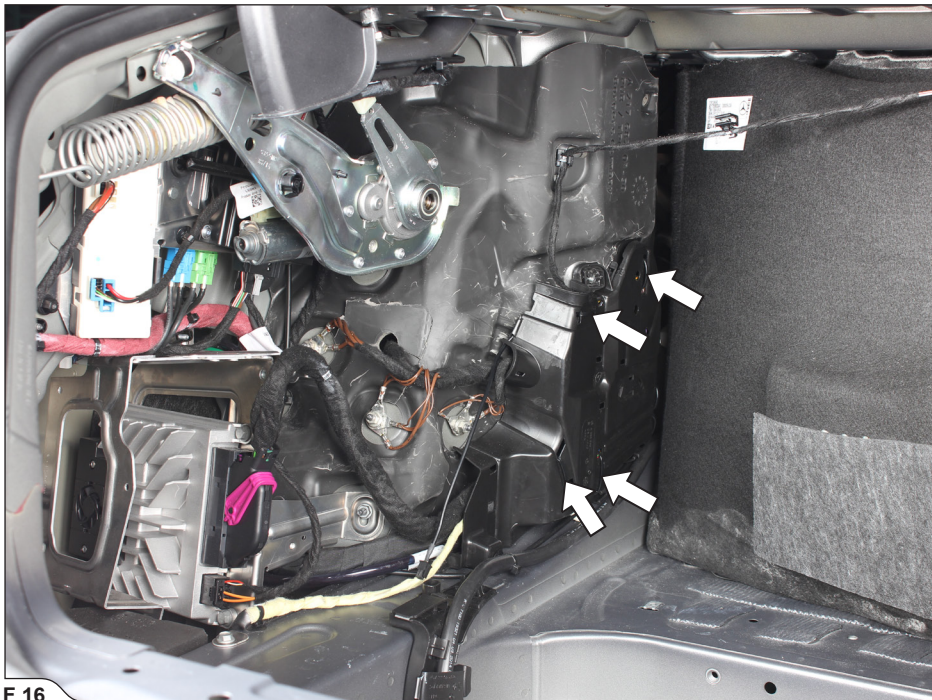

F 16

## INSTALLATION OF THE AKRAPOVIČ EXHAUST SYSTEM:

1. Connect the Sound Kit components as shown (F 17, 18):

1 - Control kit

4 - Motor kit (X Valve controller)

7 - To right actuator

2 - CAN sniffer

5 - To left stock actuator connector

8 - To left actuator

3 - Sound Kit receiver

6 - To right stock actuator connector

9 - To X valve actuator



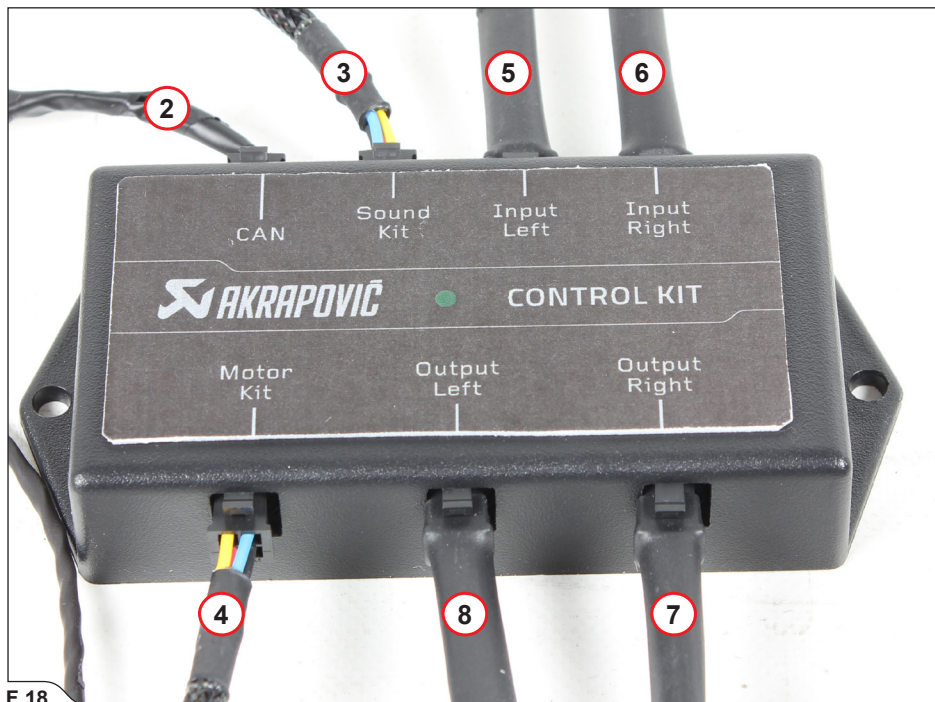

F 18

2. Place the Sound Kit into the trunk as shown (F 19).

! **CAUTION:** make sure not to damage the Sound Kit or any part of the vehicle during this process!

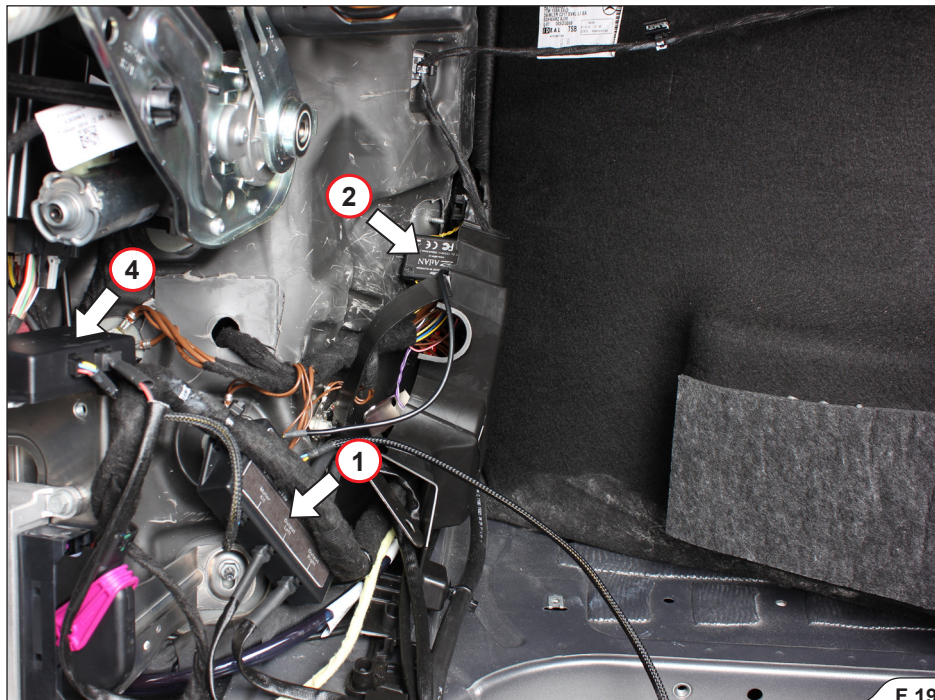

F 19

3. Unscrew the CAN sniffer's cover, lead the **yellow** and **yellow/white** wires from vehicle's wiring harness through the CAN sniffer's wire grooves as shown and reinstall the cover (F 20).

! **CAUTION:** make sure not to damage the Sound Kit or any part of the vehicle during this process!

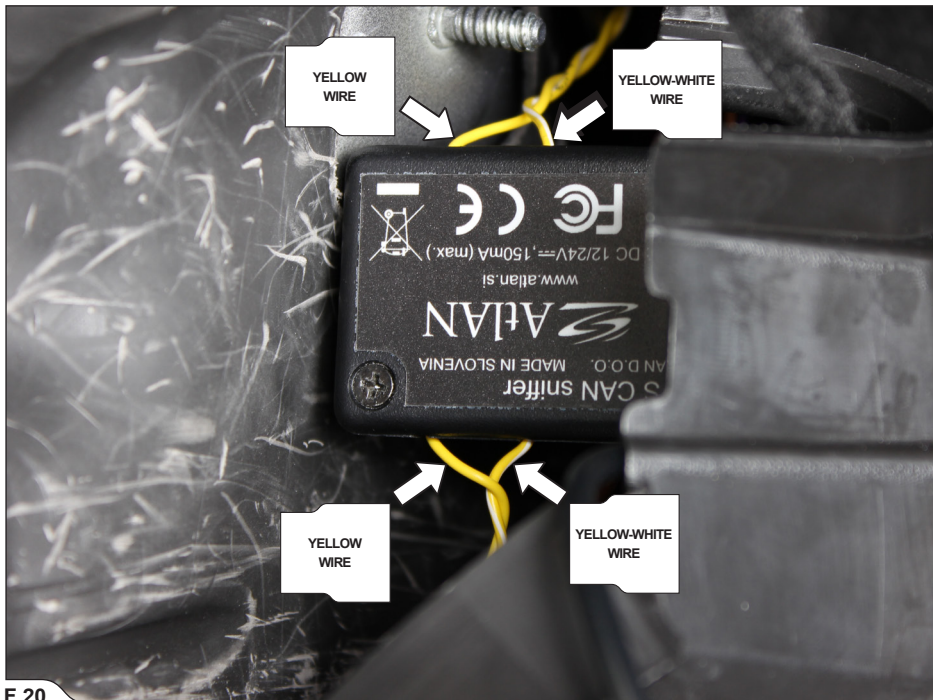

F 20



5. Secure Sound Kit components, wires and electrical harness cover, using tie wraps from Akrapovič installation kit (F 22).

! **CAUTION:** make sure not to damage the Sound Kit or any part of the vehicle during this process!

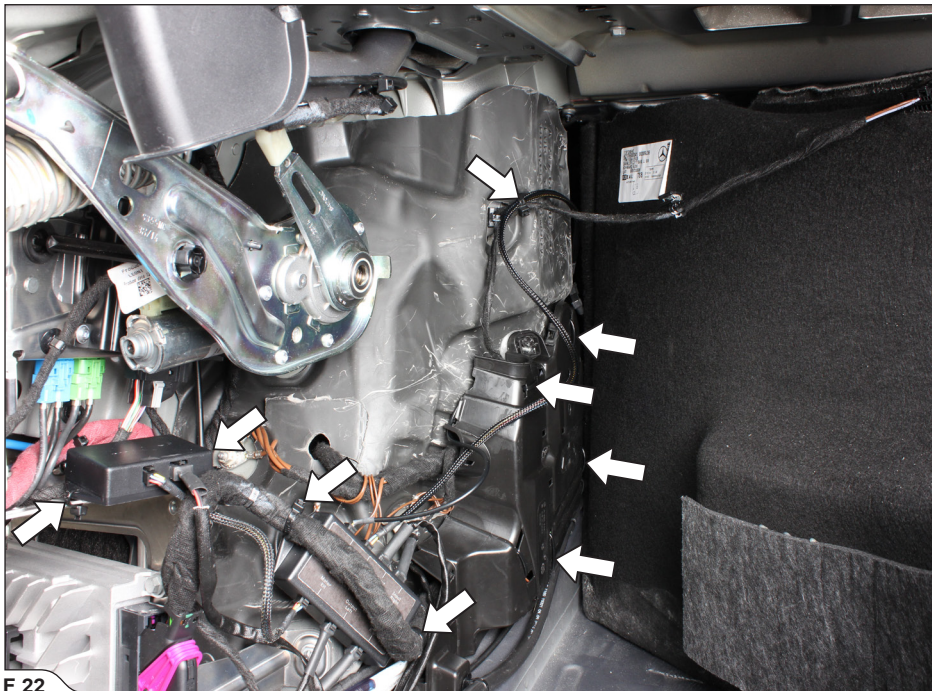

F 22

6. Lead the actuators' wiring harnesses through the chassis openings as shown and secure them in place, using tie wraps from Akrapovič installation kit (F 23, 24, 25, 26, 27).

**!** CAUTION: make sure not to damage the wiring harnesses, connectors or any part of the vehicle during this process!

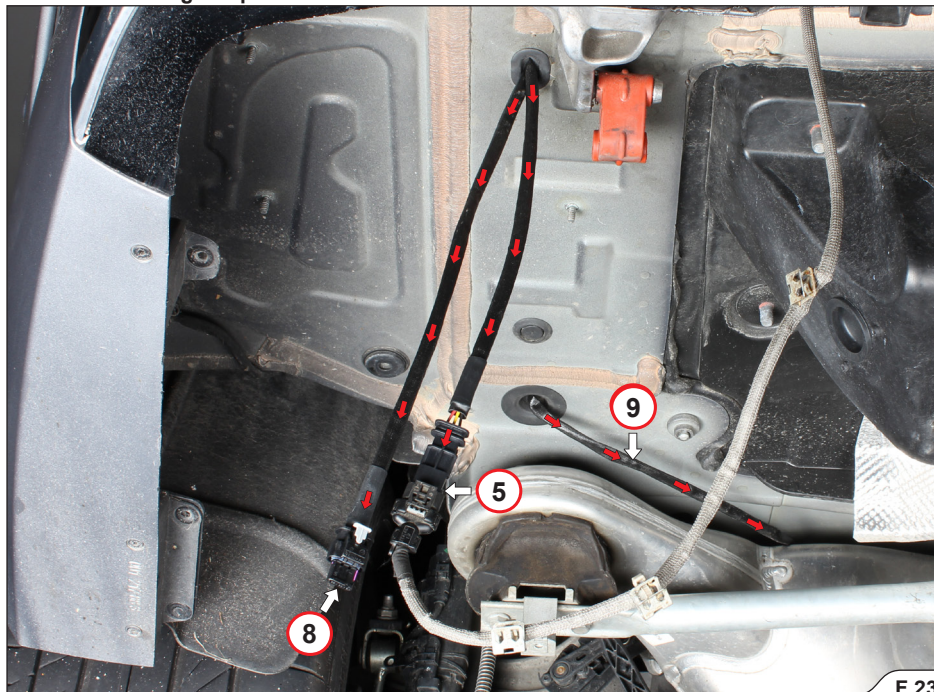



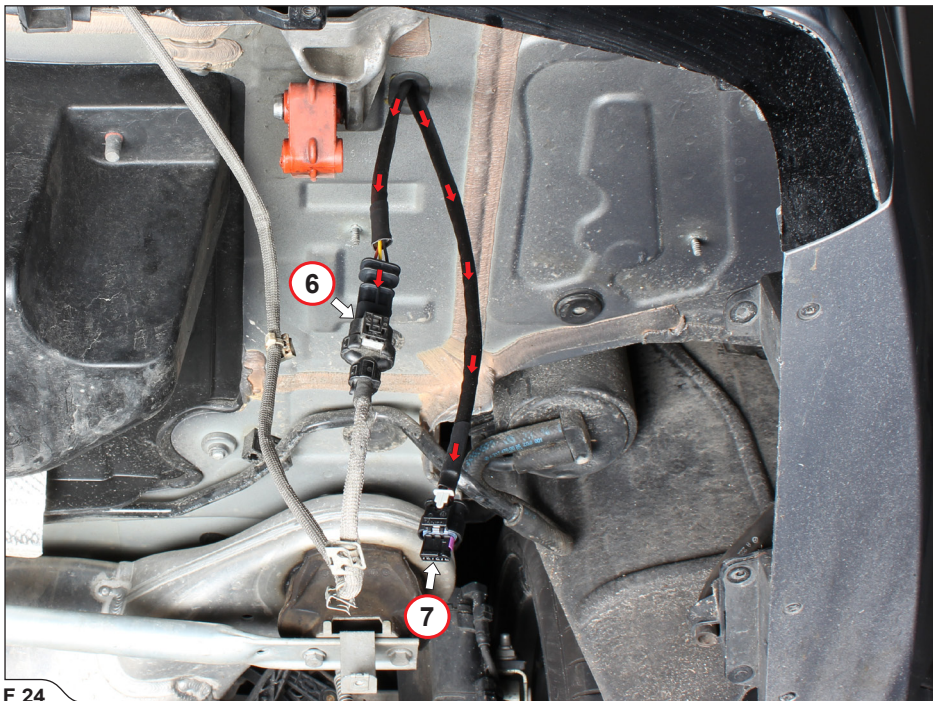

F 24

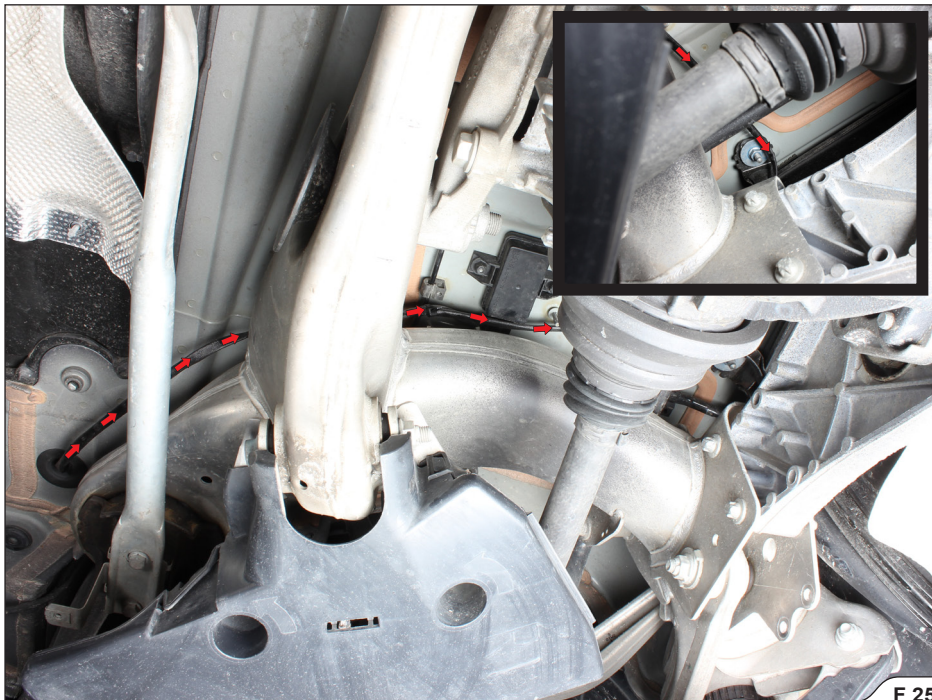

F 25



F 26

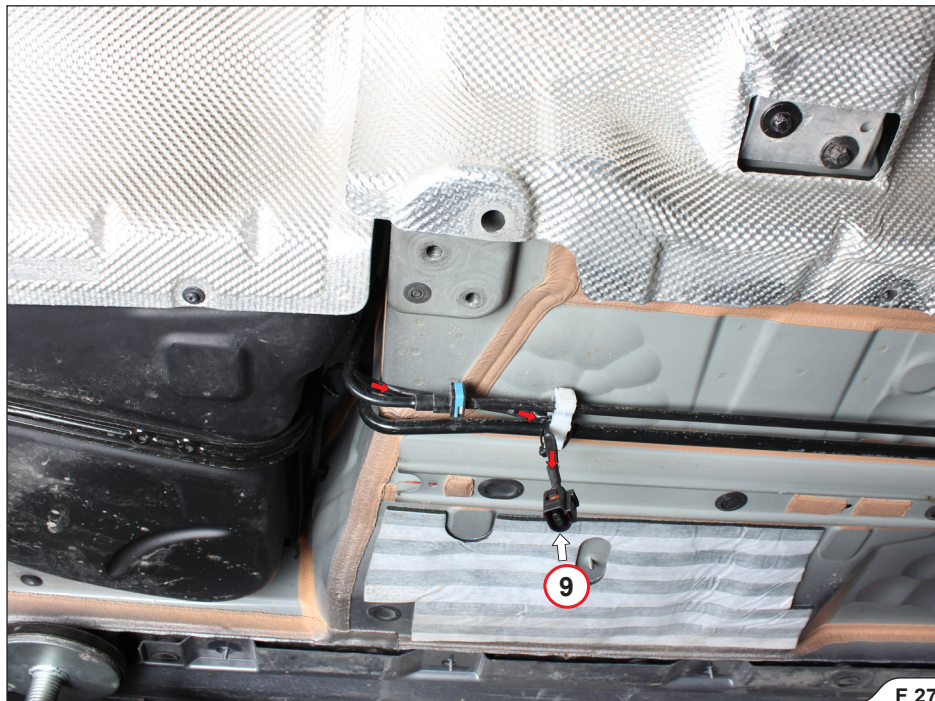

7. Carefully insert the Akrapovič tail pipes into the bumper, center them in respect to rear bumper's cut-outs and tighten them onto the bumper using stock bolts (F 28, 29, 30).
- ! **CAUTION:** make sure not to injure yourself, damage the tail pipes or any part of the vehicle during this process!



F 28

- ✂ **INSTALLATION TIP:** during installation, protect the tail pipes' carbon fiber rosettes, using masking tape or equivalent.
- ✂ **INSTALLATION TIP:** insert the tail pipes at an angle as shown (F 29).



F 29



F 30

8. Reinstall the heat protection (F 31).

! **CAUTION:** make sure not to injure yourself or damage any part of the vehicle during this process!

! **IMPORTANT:** check vehicle manufacturer manual for tightening torques.



F 31



9. Correctly orient and assemble the clamps and stock rubber brackets onto the Akrapovič link pipes (F 32, 33).

**✂** **INSTALLATION TIP:** for easier mounting, lubricate the stock rubber brackets (WD40).

**!** **IMPORTANT:** hand tighten the clamps only!

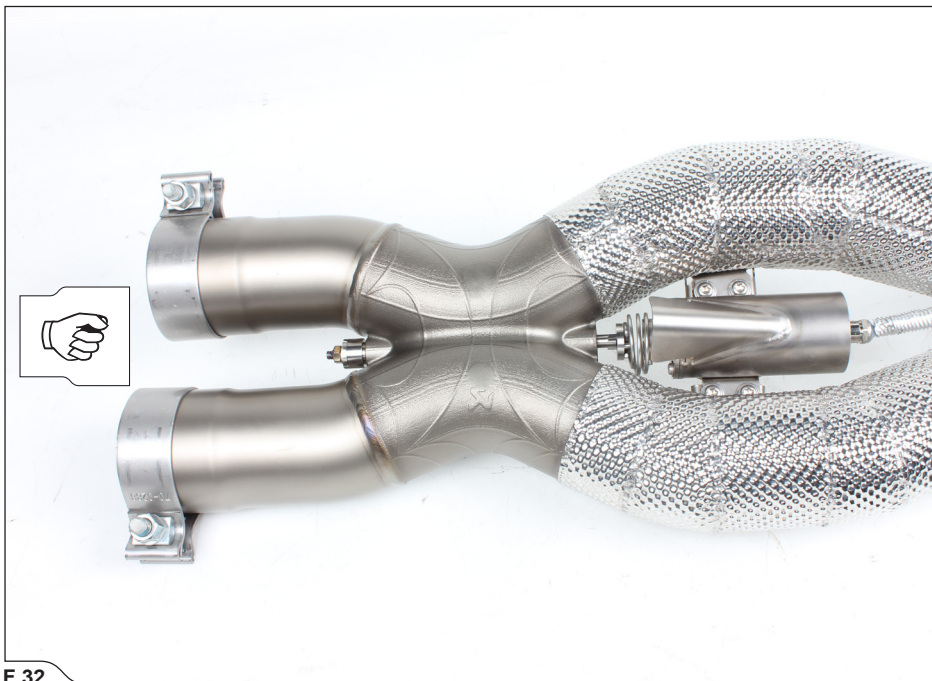

F 32

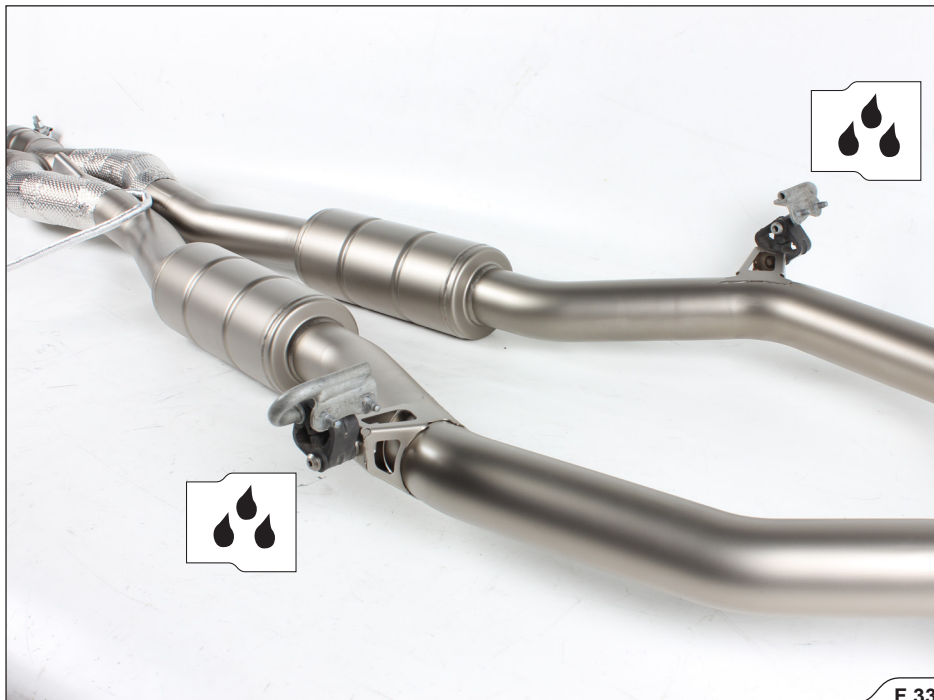

F 33

10. Slide the link pipes all the way onto the stock pipes (F 34).

! **IMPORTANT:** hand tighten the clamps only!

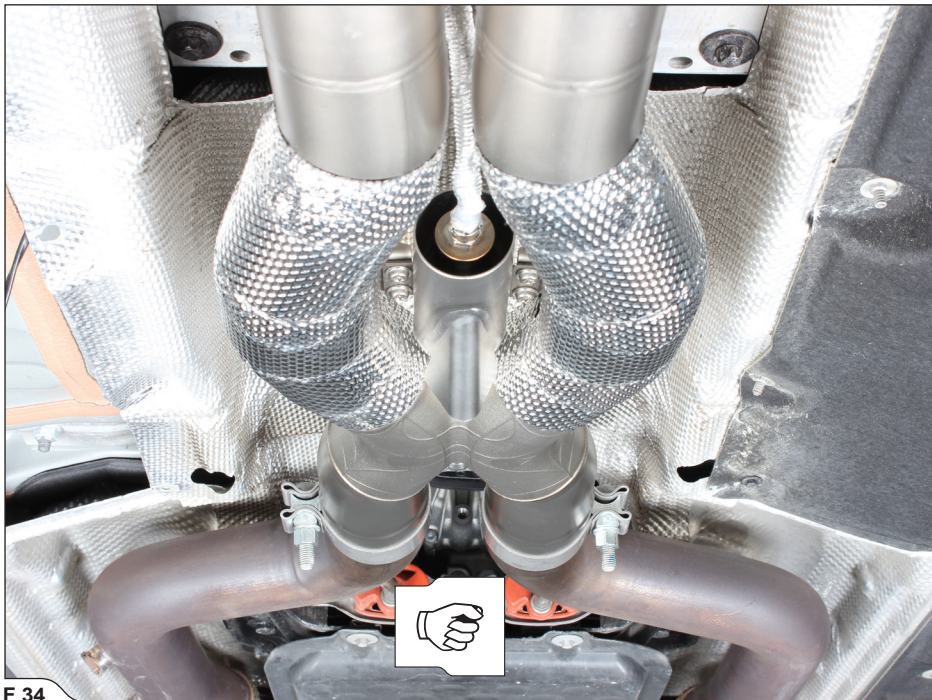

F 34

11. Unscrew the marked bolt (F 35).

! **CAUTION:** make sure not to injure yourself or damage any part of the vehicle during this process!

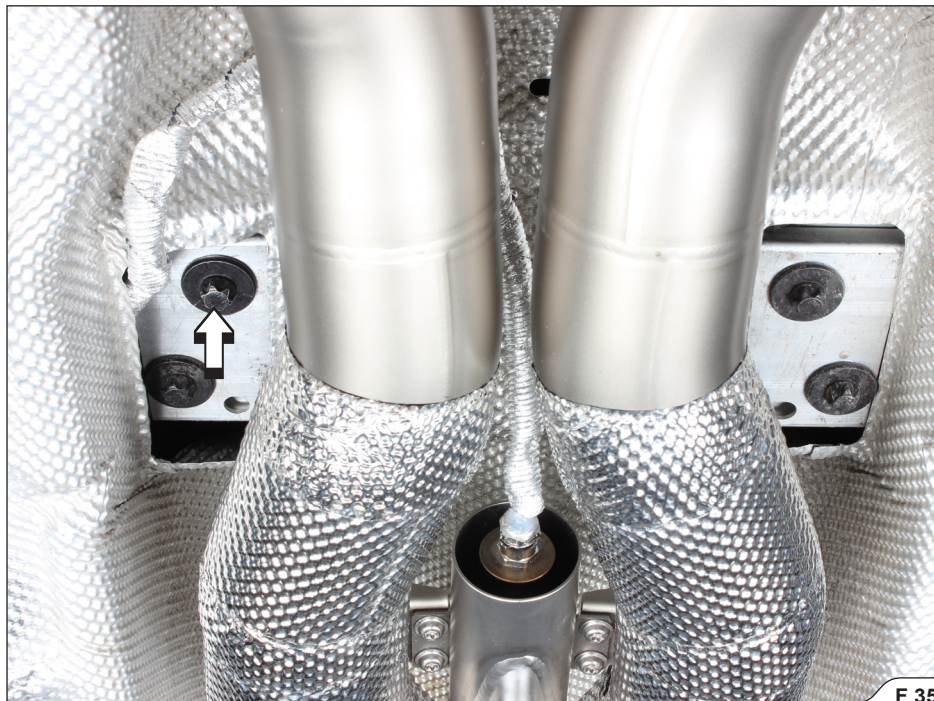

F 35

12. Install the additional harness bracket and tighten it onto the vehicle chassis using stock bolt; lead the X valve actuators' wiring harnesses as shown, connect the connectors and secure them in place, using tie wraps from Akrapovič installation kit (F 36, 37).

! **CAUTION:** make sure not to damage the wiring harnesses, connectors or any part of the vehicle during this process!

! **IMPORTANT:** use Akrapovič bolt sealant on the bolt threads!

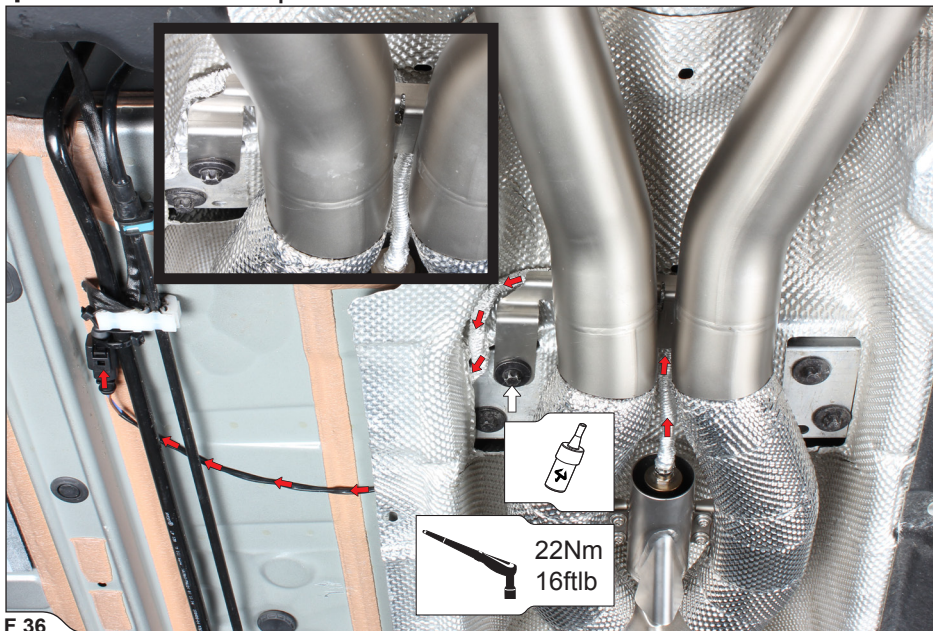

F 36



F 37

13. Correctly assemble the clamps onto the mufflers' inlet pipes (**F 38**).

**!** **IMPORTANT: hand tighten all the clamps only!**



**F 38**

14. Install the stock exhaust valve actuators onto both mufflers' valves, using bolts and nuts from Akrapovič installation kit (F 39).

! **CAUTION:** make sure not to injure yourself or damage the valves or actuators during this process!

! **IMPORTANT:** use Akrapovič bolt sealant on the nuts and bolts threads!

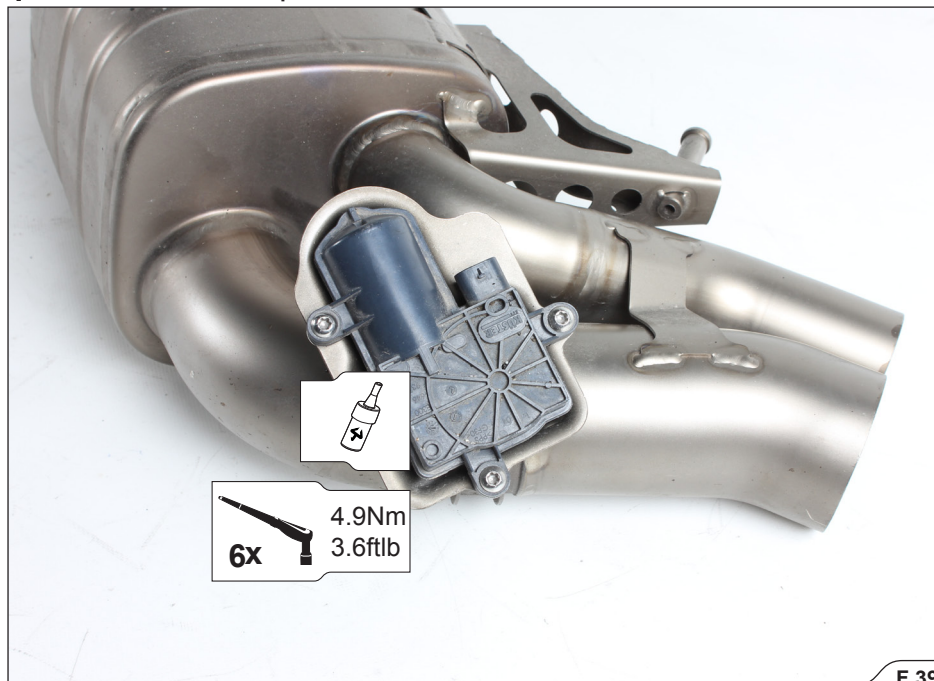



15. Slide the mufflers onto the link pipes, attach the mufflers' pins into the rubber brackets and hand tighten the clamps (F 40, 41, 42).

**✚** **INSTALLATION TIP:** for easier mounting, lubricate the stock rubber brackets (WD40).

**!** **IMPORTANT:** hand tighten all the clamps only!

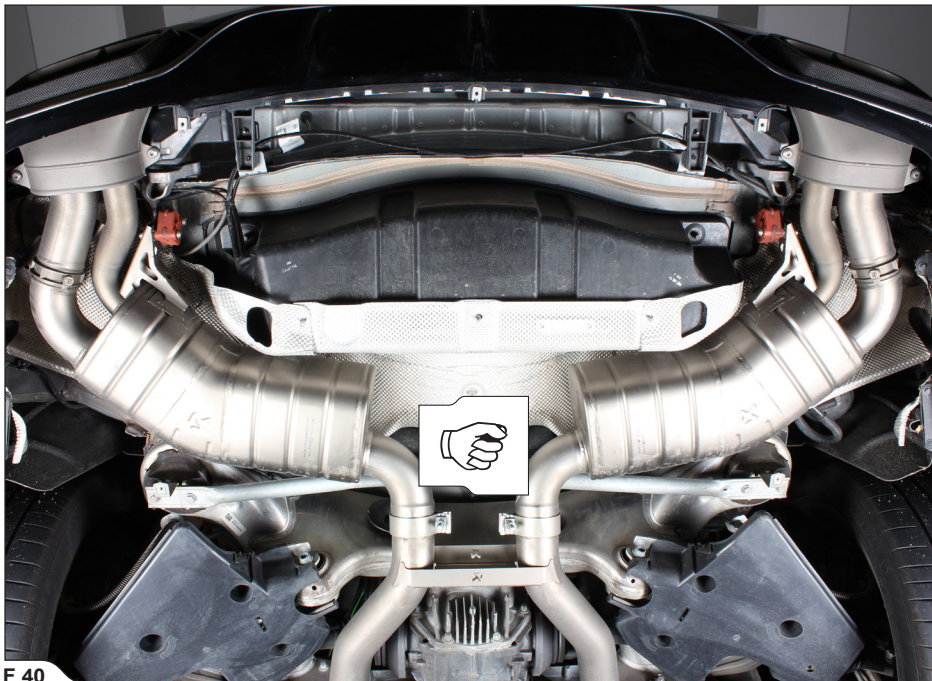

F 40

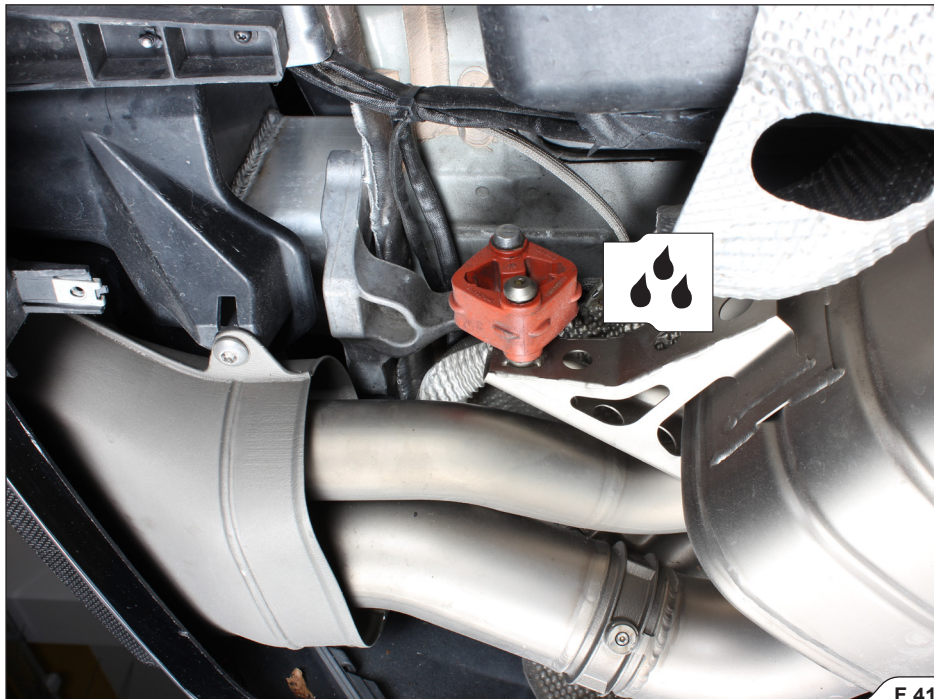

F 41

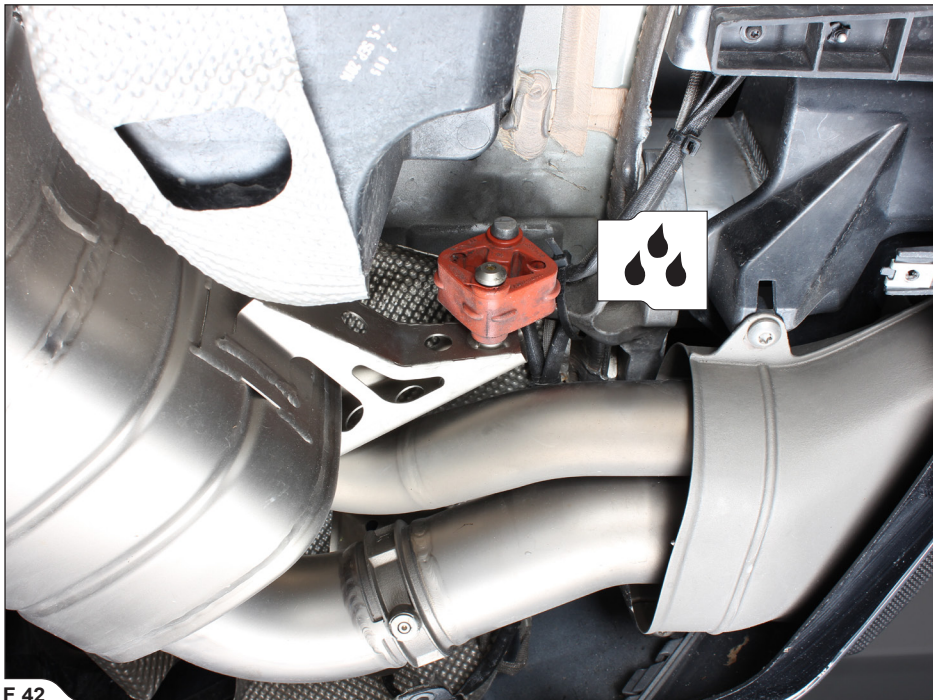

F 42

16. Tighten the link pipes' rubber brackets onto the chassis and reinstall the chassis reinforcement and the left side underfloor panel (F 43).

! **IMPORTANT:** check vehicle manufacturer manual for stock parts tightening torques.

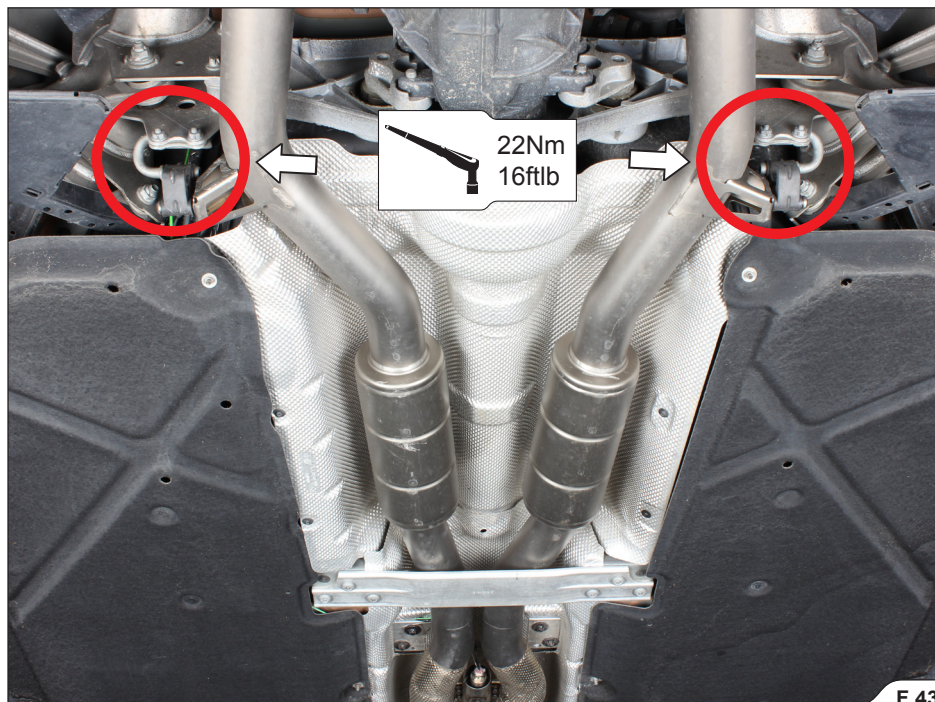

F 43

17. Slide the link pipes all the way onto the stock pipes and tighten the clamps to the specified torque (F 44).

! CAUTION: make sure not to injure yourself or damage any part of the exhaust system during this process!

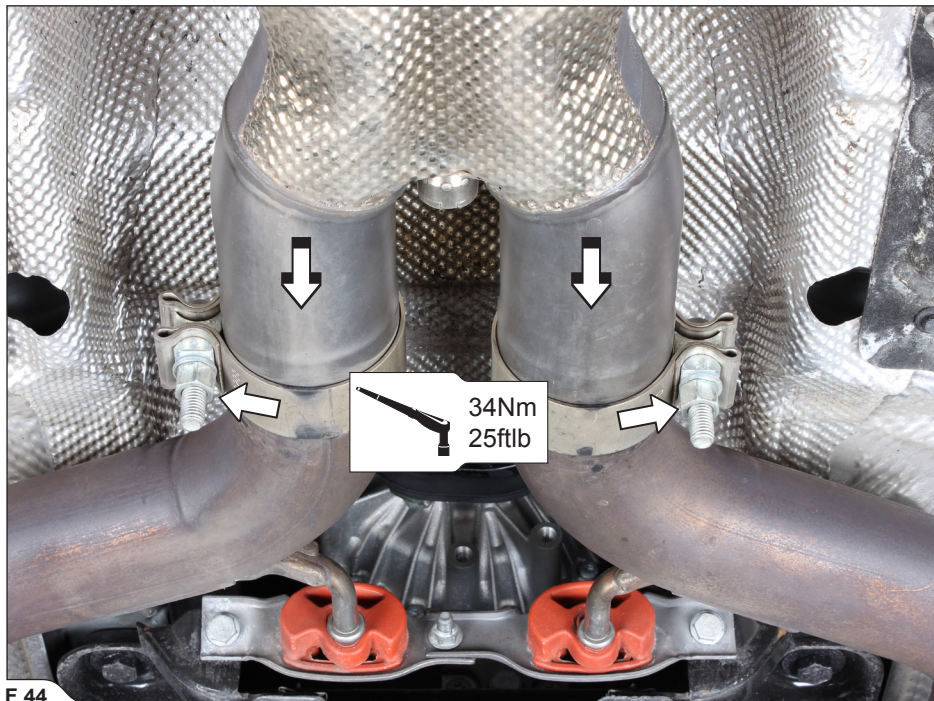

F 44

- Slide the mufflers all the way onto the link pipes and tighten the clamps to the specified torque (F 45).

**!** CAUTION: make sure not to injure yourself or damage any part of the exhaust system during this process!

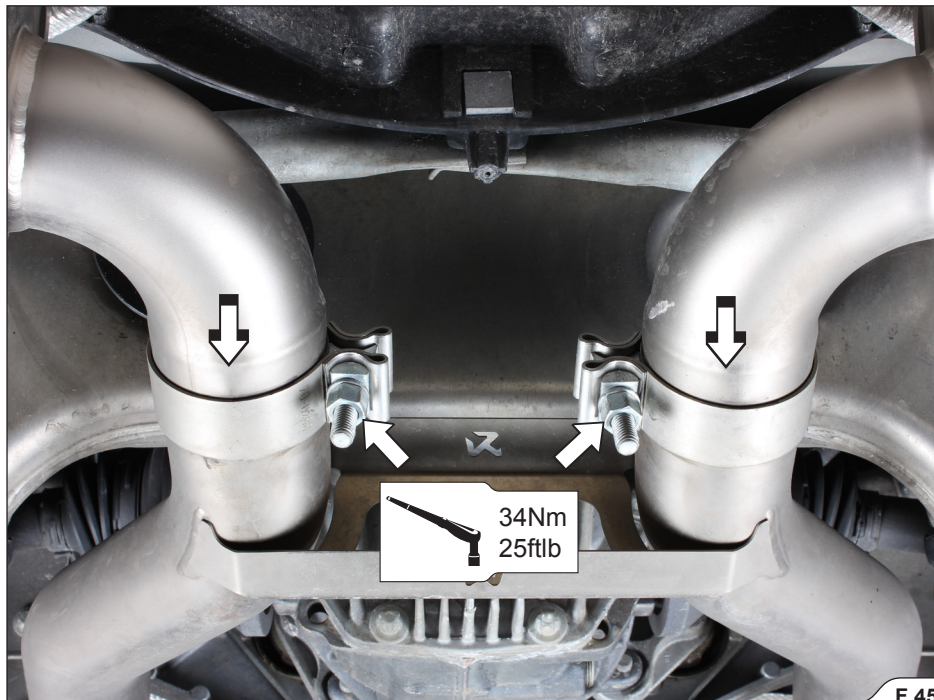

19. Reinstall all dismantled or partially removed stock parts; check vehicle manufacturer manual for correct procedures and tightening torques (F 46).

! **CAUTION:** make sure not to injure yourself or damage any part of the exhaust system during this process!



F 46

## FINAL INSTALLATION:

- ! **IMPORTANT:** reinstall the dismantled or partially removed stock parts (wheel arches, bumper etc.); check vehicle manufacturer manual for tightening torques.
- ! **IMPORTANT:** make sure all the nuts and bolts are sufficiently tightened. In case the exhaust system touches the cowlings or other parts, repeat the adjustment of the exhaust system or contact your authorized dealer.

## MAINTENANCE OF THE AKRAPOVIČ EXHAUST SYSTEM:

1. Clean the titanium exhaust components with a multi-purpose spray lubricant (WD-40 or equivalent), carbon fiber exhaust components with soft and dry cloth and stainless steel components with soft cloth sprayed with contact cleaner, then wipe with soft and dry cloth. A change in the color of the exhaust system is normal due to high temperatures.
2. Periodically make sure all the bolts and springs are sufficiently tight.

- ! **IMPORTANT:** clean all exhaust components before the first start of the engine or the stains will burn onto the surfaces!
- ! **IT IS NORMAL FOR WHITE SMOKE TO COME OUT OF THE MUFFLER AT FIRST OPERATION.**
- ! **DO NOT STAND BEHIND THE MUFFLER AT FIRST OPERATION.**
- ! **DO NOT USE AUTOMOTIVE WHEEL CLEANERS OR ANY CLEANING PRODUCTS WHICH CONTAIN ACIDIC ADDITIVES TO CLEAN THE AKRAPOVIČ EXHAUST SYSTEMS.**

**WARNING: THE EXHAUST SYSTEM CAN BE EXTREMELY HOT. ALLOW THE EXHAUST AND ENGINE TO COOL DOWN BEFORE BEGINNING INSTALLATION. THIS MANUAL IS SPECIFIC TO THE MERCEDES-AMG S63 COUPE TYPE C217. THERE MAY BE SOME DIFFERENCES IN INSTALLATION PROCEDURES FOR OTHER MODELS.**



## TROUBLESHOOTING:

Problem	Possible cause	Solution
Exhaust gas leaks out of the muffler/pipe clamp connections	loosened clamp	tighten the clamp to specified torque
	connection is not completely joined	tap the connection into place and tighten the clamp to specified torque
Valves are not moving	No supply	Check green LED on the Control Kit. If the LED is off: <ul style="list-style-type: none"><li>• Check electrical connection and connectors</li><li>• Check fuse for exhaust valves (in the trunk, right)</li></ul>
	Error detected	Check green LED on the Control Kit. If the LED is blinking fast: <ul style="list-style-type: none"><li>• Check electrical connections and connectors</li><li>• Try to use the Sound Kit remote controller. If valves are turning, then check how the Communication sensor is installed</li></ul>

## DECLARATION OF CONFORMITY OF CONTROL KIT

COMPANY: Akrapovič d.d.  
ADDRESS: Malo Hudo 8a  
1295 Ivančna Gorica, Slovenia

declares that the following products:

Product name: Control Kit  
Trade Name: Akrapovič  
Type or model: P-HF886

is in conformity with the requirements of the following Directives of the European Union:  
Regulation UN/ECE-R10 rev5



10 R - 05 1139

## FCC NOTICE

This device complies with part 15 of the FCC rules. Operation is subject to the following two conditions: **(1)** This device may not cause harmful interference, and **(2)** this device must accept any interference received, including interference that may cause undesired operation.

Changes or modifications not expressly approved by the party responsible for compliance could void the user's authority to operate the equipment.

You can view your product's FCC Declaration of Conformity (DoC) to the FCC 47 CFR Part 15, SubpartB, at <http://www.akrapovic.com/docs/ControlKit/FCCCertification.pdf>.

## Industry Canada compliance statement

**This Class B digital apparatus complies with Canadian ICES-003.** This device complies with Industry Canada licence-exempt RSS standard(s). Operation is subject to the following two conditions:

**(1)** this device may not cause interference, and **(2)** this device must accept any interference, including interference that may cause undesired operation of the device.

**Cet appareil numérique de la classe B est conforme à la norme NMB-003 du Canada.** Le présent appareil est conforme aux CNR d'Industrie Canada applicables aux appareils radio exempts de licence. L'exploitation est autorisée aux deux conditions suivantes :

**(1)** l'appareil ne doit pas produire de brouillage, et **(2)** l'utilisateur de l'appareil doit accepter tout brouillage radioélectrique subi, même si le brouillage est susceptible d'en compromettre le fonctionnement.

## European Union Directives Conformance Statement



Akrapovič d.d. hereby declares that this Akrapovič Control Kit P-HF886 is in compliance with the essential requirements and other relevant provisions of Directive 2004/108/EU

You can view your product's Declaration of Conformity (DoC) to Directive 2004/108/EU (to EMC Directive) at <http://www.akrapovic.com/docs/ControlKit/CECertification.pdf>.

## DECLARATION OF CONFORMITY FOR MOTOR KIT

COMPANY: Akrapovič d.d.  
ADDRESS: Malo Hudo 8a  
1295 Ivančna Gorica, Slovenia

declares that the following products:

Product name: Motor Kit  
Trade Name: Akrapovič  
Type or model: P-HF911

is in conformity with the requirements of the following Directives of the European Union:  
Regulation UN/ECE-R10 rev5



10 R - 05 1164

### European Union Directives Conformance Statement

**CE** Akrapovič d.d. hereby declares that this Akrapovič Motor Kit P-HF911 is in compliance with the essential requirements and other relevant provisions of Directive 2004/108/EU

You can view your product's Declaration of Conformity (DoC) to Directive 2004/108/EU (to EMC Directive) at <http://www.akrapovic.com/docs/MotorKit/CECertification.pdf>.



## DECLARATION OF CONFORMITY

COMPANY: Atlan d.o.o.  
ADDRESS: Sveti Anton, Hrib 9  
6276 Pobegi, Slovenia

declares that the following products:

Product name: Communication Detector  
Trade Name: Atlan  
Type or model: VTS CAN SNIFFER

is in conformity with the requirements of the following Directives of the European Union:  
Regulation UN/ECE-R10 rev5



10 R - 05 1141

## FCC NOTICE

This device complies with part 15 of the FCC rules. Operation is subject to the following two conditions: **(1)** This device may not cause harmful interference, and **(2)** this device must accept any interference received, including interference that may cause undesired operation.

Changes or modifications not expressly approved by the party responsible for compliance could void the user's authority to operate the equipment.

You can view your product's FCC Declaration of Conformity (DoC) to the FCC 47 CFR Part 15, SubpartB, at <http://www.akrapovic.com/docs/CanSniffer/FCCCertification.pdf>.

## Industry Canada compliance statement

**This Class B digital apparatus complies with Canadian ICES-003.** This device complies with Industry Canada licence-exempt RSS standard(s). Operation is subject to the following two conditions:

**(1)** this device may not cause interference, and **(2)** this device must accept any interference, including interference that may cause undesired operation of the device.

**Cet appareil numérique de la classe B est conforme à la norme NMB-003 du Canada.** Le présent appareil est conforme aux CNR d'Industrie Canada applicables aux appareils radio exempts de licence. L'exploitation est autorisée aux deux conditions suivantes :

**(1)** l'appareil ne doit pas produire de brouillage, et **(2)** l'utilisateur de l'appareil doit accepter tout brouillage radioélectrique subi, même si le brouillage est susceptible d'en compromettre le fonctionnement.

## European Union Directives Conformance Statement

**CE** Atlán d.o.o. hereby declares that this Atlán Communication Detector VTS CAN SNIFFER is in compliance with the essential requirements and other relevant provisions of Directive 2004/108/EU

You can view your product's Declaration of Conformity (DoC) to Directive 2004/108/EU (to EMC Directive) at <http://www.akrapovic.com/docs/CanSniffer/CECertification.pdf>.

[www.akrapovic.com](http://www.akrapovic.com)

