

TP-T/S/19
FOR STOCK DIFUSSOR

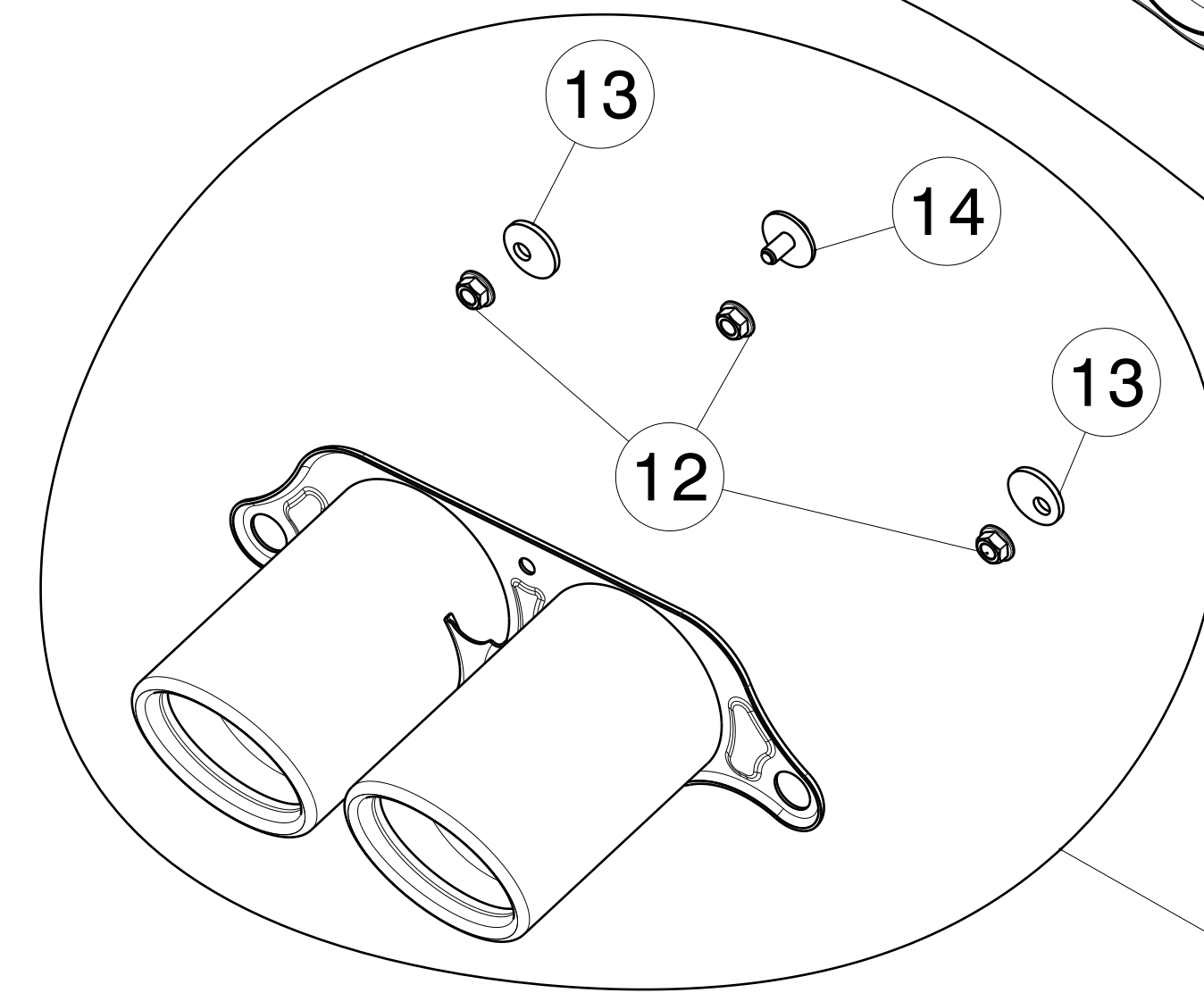

WITH AKRAPOVIČ DIFUSSOR
TP-T/S/17

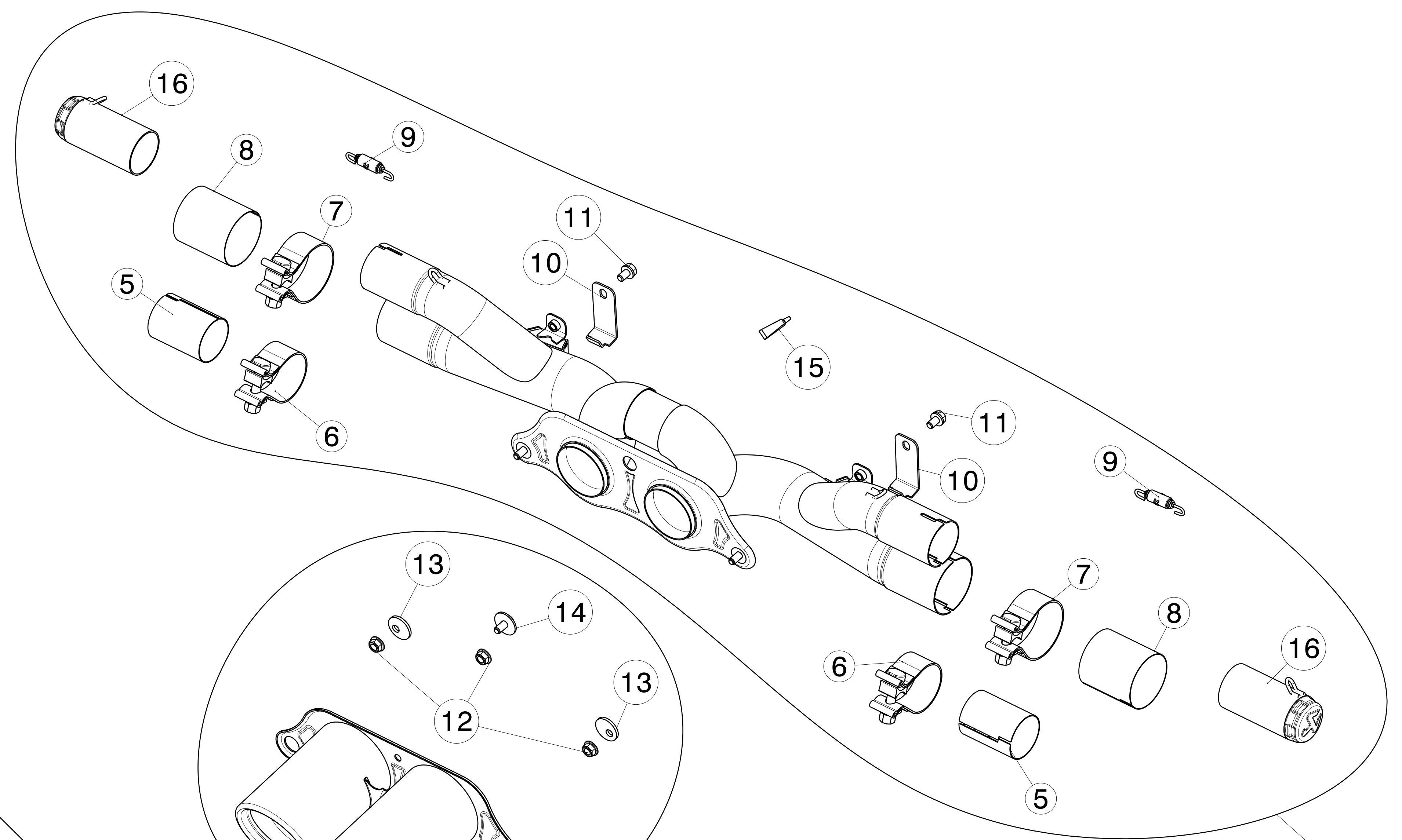
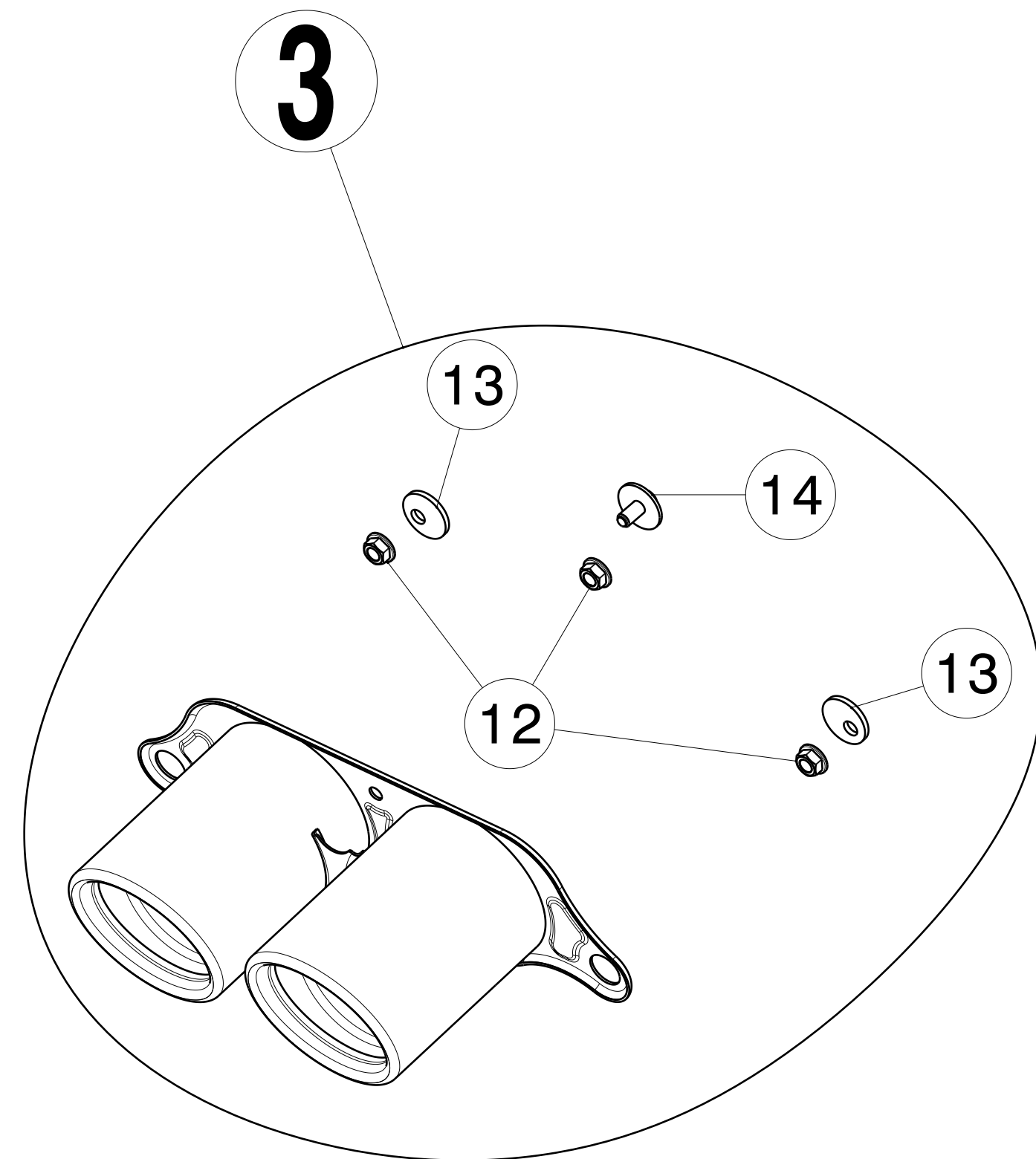
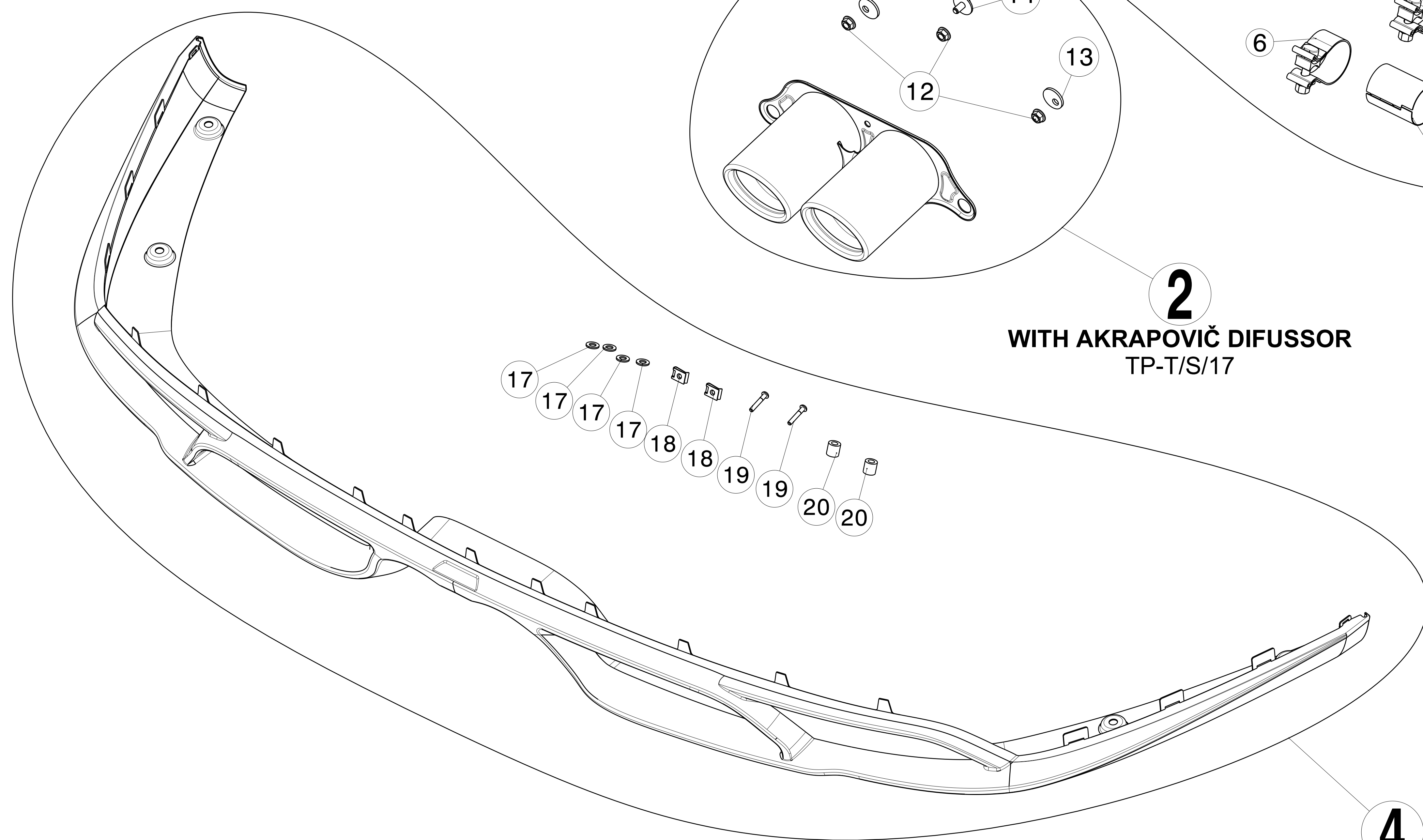

DI-PO/CA/7/G

**Note: Diffuser DI-PO/CA/7/G has to be used with tail pipe set TP-T/S/17
Slip-on system for GT3 RS OPF model must be mandatory combined with Evolution Header Set (E-PO/T/6)**

No.	SalesCode	Description	Qty.
3	TP-T/S/19	tail pipe TI	1
12	P-FN12	nut	3
13	P-DR92	washer TI	2
14	P-DR146	washer (TI)	1